

# TRACTO

## GRUNDODRILL ACCESSORIES

Order now  
at our  
eSHOP



[eSHOP.TRACTO.COM](https://eshop.tracto.com)

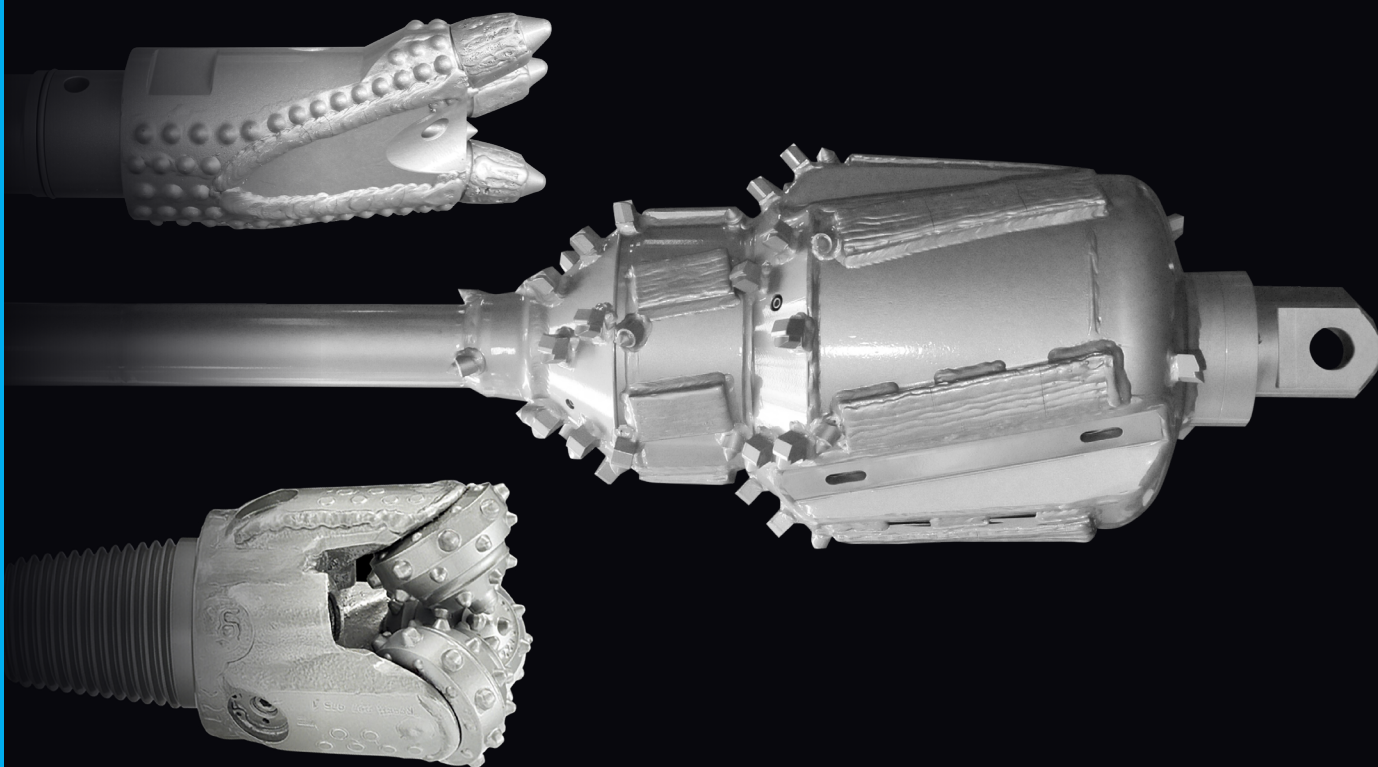

**ADVANCED TRENCHLESS TECHNOLOGY**

## Table of contents

Pilot bore heads	3
Sonde housings	14
Quick-Connector	16
Drill rods	20
Backreamers	22
Swivels	34
Push heads	35
Pipe pullers	37
Rock drilling technique	43
Detection technique	63
Tensile load measuring	69
Trenchless cable exchange	72
Retrieval tools	74

# Pilot bore heads

for clay, silt, loam, marl  
Soft Drill Head (SDH)

- for non-cohesive soils
- in case of wear only the steering plate is exchange
- easy exit of the bore channel
- different steering plates available
- durable and robust construction
- optimal reflux of the bore spoils

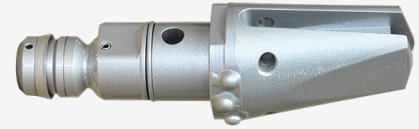

## For muzzleloader transmitter housing

Soft Drill Head 4X / TD 48 / TD 61 / EL D67 - Ø 80/66 mm for muzzleloader transmitter housing

Part No.: DRI 4790

Soft Drill Head für TD 73, EL D80 - Ø 110/85 mm for muzzleloader transmitter housing

Part No.: DRI 144780.1

Soft Drill Head für TD 82 - Ø 120/99 mm for muzzleloader transmitter housing

Part No.: DRI 4800

## For side loader transmitter housing

Soft Drill Head for TD 73, EL D80 - Ø 110/85 mm for side loader transmitter housing

Part No.: DRI 144780.2

Soft Drill Head for TD 82 - Ø 120/99 mm for side loader transmitter housing

Part No.: DRI 4800

Soft Drill Head for EL D104 - Ø 104 mm for side loader transmitter housing

Part No.: DRI 4852

# Pilot bore heads

## Steering plates for SDH Soft Drill Head

Due to the different steering plate geometries the SDH bore head can be adapted to different types of soil.

Steering plate type Standard for TD 82 L 200 mm  
with hard metal pins  
length 200 mm

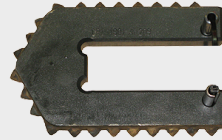

Part No.: DRI 4801

Steering plate type Standard for TD 82 L 240 mm  
with hard metal pins  
length 240 mm

Part No.: DRI 4802

Steering plate type Standard for TD 48, TD 61, TD 73, Rd 49, EL D67,  
EL D80  
with hard metal pins  
Length 135 mm

Part No.: DRI 4791

Steering plate type Standard for TD 48, TD 61, TD 73, Rd 49, EL D67,  
EL D80  
with hard metal pins  
Length 175 mm

Part No.: DRI 4792

Steering plate type Standard for TD 48, TD 61, TD 73, Rd 49, EL D67,  
EL D80  
with hard metal pins  
Length 205 mm

Part No.: DRI 4793

Steering plate type Standard for TD 48, TD 61, TD 73, Rd 49, EL D67,  
EL D80  
with hard metal pins  
Length 175 mm x Breite 110 mm

Part No.: DRI 4794

Steering plate type Triangle for TD 61, TD 73, Rd 49  
with hard metal pins, for larger freecutting of the drill rod  
length 135 mm x width 125 mm



Part No.: DRI 4796

Steering plate type Triangle for TD 82  
with hard metal pins, for larger freecutting of the drill rod  
length 200 mm x width 160 mm

Part No.: DRI 4803



# Pilot bore heads

Steering plate TD 61, TD 73, Rd 49, EL D67, EL D80  
for very soft ground  
W 150 mm

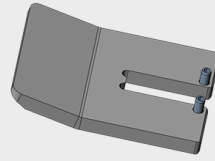

Part No.: DRI 4797.2

Steering plate bent for TD 61, TD 73, Rd 49, EL D67, EL D80  
for even better steering behaviour  
Length 200 mm x Width 135 mm

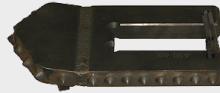

Part No.: DRI 4797

Steering plate bent for TD 82, EL D104  
for even better steering behaviour  
length 260 mm x Width 150 mm



Part No.: DRI 4806

Steering plate with weld-on teeth for TD 61, TD 73, Rd 49, EL D67,  
EL D80  
For hard, compact, sandy and gravelly soils  
Length 180 mm x Width 130 mm



Part No.: DRI 4798

Steering plate with weld-on teeth for TD 82, EL-D104  
For hard, compact, sandy and gravelly soils  
Length 260 mm x Width 190 mm



Part No.: DRI 4807

Steering plate with weld-on teeth for TD 82, EL D104  
For hard, compact, sandy and gravelly soils  
Width 280 mm



Part No.: DRI 4808

# Pilot bore heads

for fine sand up to medium gravel soils  
Medium Drill Head (MDH) Type 1

- with exchangeable round-framed chisels
- preferably for cohesive soils
- optimal reflux of the bore spoils
- chisel geometry adapted to the percussive hammer (exchangeable blades)
- very easy to steer, low friction on the drill rod
- easy exit of the bore channel



## For muzzleloader transmitter housing

Medium Drill Head Type 1 for 4X - Ø 80 mm

Part No.: PIT 4713

MDH-Gravel Type - Medium Drill Head Typ 1 for TD 61 und EL D67 -  
Ø 100 mm

Part No.: DRI 4820

MDH-Gravel Type - Medium Drill Head Typ 1 for TD 73, EL D80 - Ø  
115 mm

Part No.: DRI 144781.1

Medium Drill Head Type 1 for TD 82 - Ø 150 mm

Part No.: DRI 4826

Medium Drill Head Type 1 for TD 82 / EL 95 - Ø 190 mm

Part No.: DRI 4827

## For side loader transmitter housing

MDH-Gravel Type - Medium Drill Head Typ 1 für TD 73 - Ø 115 mm  
for side loader transmitter housing

Part No.: DRI 144781.2

Medium Drill Head Typ 1 für EL D104 - Ø 190 mm for side loader  
transmitter housing

Part No.: DRI 4850

MDH-Gravel Type - Medium Drill Head Typ 1 für TD 82 - Ø 150 mm  
for side loader transmitter housing

Part No.: DRI 4826.2

Medium Drill Head Type 1 for TD 82 / EL 95 - Ø 190 mm for side  
loader transmitter housing

Part No.: DRI 4827.2

# Pilot bore heads

for fine sand up to medium gravel soils  
Medium Drill Head (MDH) Type 2

with slanted round-framed chisels

- universally applicable
- for densely layered, difficult to penetrate soils

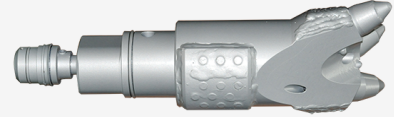

## For muzzleloader transmitter housing

Medium Drill Head Type 2 for TD 61, EL D67 - Ø 115 mm for  
Muzzleloader Transmitter Housing

Part No.: DRI 4820.1

Medium Drill Head Typ 2 for TD 73, EL D80 - Ø 135 mm for  
Muzzleloader Transmitter Housing

Part No.: DRI 144785.1

Medium Drill Head Typ 2 for TD 82 - Ø 150 mm for Muzzleloader  
Transmitter Housing

Part No.: DRI 4822

## For side loader transmitter housing

Medium Drill Head Typ 2 für TD 73 - Ø 135 mm for side loader  
transmitter housing

Part No.: DRI 144785.2

Medium Drill Head Typ 2 für TD 82 - Ø 150 mm for side loader  
transmitter housing

Part No.: DRI 4822.2

Medium Drill Head Typ 2 for EL D104 - Ø 170 mm for side loader  
transmitter housing

Part No.: DRI 4854

# Pilot bore heads

for fine sand up to medium gravel soils  
Medium Drill Head (MDH) Type 3

- for hard, compact, sandy and gravelly soils
- rigid construction
- excellent steering characteristics



## For muzzleloader transmitter housing

Medium Drill Head Typ 3 for TD 61, EL D67 - Ø 120 mm For muzzleloader transmitter housing

Part No.: DRI 4790.5

Medium Drill Head Typ 3 for TD 73, EL D80 - Ø 135 mm, For muzzleloader transmitter housing

Part No.: DRI 4799

Medium Drill Head Typ 3 for TD 82 - Ø 170 mm for muzzleloader transmitter housing

Part No.: DRI 4823

## For side loader transmitter housing

Medium Drill Head Typ 3 for TD 73, EL D80 - Ø 135 mm, For side loader transmitter housing

Part No.: DRI 4799

Medium Drill Head Typ 3 für TD 82 - Ø 170 mm, for side loader transmitter housing

Part No.: DRI 4823.2

# Pilot bore heads

for coarse gravel mixed soils, debris, hard and aggressive soils  
Hard Drill Head (HDH) Type 1

- for non-homogeneous soils
- preferably for rubble
- very easy to steer
- easy exit of bore channel
- high wear protection



## For muzzleloader transmitter housing

Hard Drill Head Typ 1 - Ø 85 mm, for muzzleloader transmitter housing

Part No.: DRI 4790.9

Hard Drill Head Typ 1 für TD 61, EL D67 - Ø 95 mm for muzzleloader transmitter housing

Part No.: DRI 4790.6

Hard Drill Head Typ 1 für TD 61, EL D67 - Ø 115 mm for muzzleloader transmitter housing

Part No.: DRI 4790.7

Hard Drill Head Typ 1 für TD 73, EL D80 - Ø 115 mm for muzzleloader transmitter housing

Part No.: DRI 144784.1

Hard Drill Head Typ 1 for TD 73, EL D80 - Ø 125 mm with exchangeable round framed chisels

Part No.: DRI 144784.3

Hard Drill Head Typ 1 für TD 82 - Ø 130 mm for muzzleloader transmitter housing

Part No.: DRI 4825.3

Hard Drill Head Typ 1 für TD 82 / EL 95 - Ø 155 mm for muzzleloader transmitter housing

Part No.: DRI 4825.4

## For side loader transmitter housing

Hard Drill Head Typ 1 für TD 73 - Ø 115 mm für Seitenlader-Sendergehäuse

Part No.: DRI 144784.2

Hard Drill Head Typ 1 for TD 73, EL D80 - Ø 125 mm, with exchangeable round framed chisels

Part No.: DRI 144784.4

Hard Drill Head Typ 1 for TD 82 - Ø 130 mm for side loader transmitter housing

Part No.: DRI 4825.3

Hard Drill Head Typ 1 for TD 82 / EL 95 - Ø 155 mm for side loader transmitter housing

Part No.: DRI 4825.4

Hard Drill Head Typ 1 für EL D104 - Ø 155 mm for side loader transmitter housing

Part No.: DRI 4851

Hard Drill Head Typ 1 für EL D104 - Ø 195 mm for side loader transmitter housing

Part No.: DRI 4851

# Pilot bore heads

for coarse gravel mixed soils, debris, hard and aggressive soils  
Hard Drill Head (HDH) Type 2

- for medium heavy to heavy homogeneous, fissured and loose soils,
- also for hard, non-displaceable soils,
- extremely high wear protection due to hard metal armouring,
- very good return flow of exiting spoils



## For muzzleloader transmitter housing

Hard Drill Head Typ 2 for TD 48 / TD 61 - Ø 80 mm, only for transmitter housing Ø 65 mm - muzzleloader

Part No.: DRI 4735

Hard Drill Head Typ 2 for TD 61, EL D67 - Ø 95 mm, for transmitter housing Ø 75 mm - muzzleloader

Part No.: DRI 4790.2

Hard Drill Head Typ 2 für TD 73, EL D80 - Ø 115 mm, for muzzleloader transmitter housing

Part No.: DRI 144782.1

Hard Drill Head Typ 2 für TD 82 - Ø 120 mm for muzzleloader transmitter housing

Part No.: DRI 4810.2

## For side loader transmitter housing

Hard Drill Head Typ 2 für TD 73 - Ø 115 mm, for side loader transmitter housing

Part No.: DRI 144782.2

Hard Drill Head Typ 2 für TD 82 - Ø 120 mm for side loader transmitter housing

Part No.: DRI 4810.2

# Pilot bore heads

for hard, compact, non-displaceable soils  
Hard Drill Head (HDH) 4-finger

- for all mixed soils
- Debris, hard and aggressive soils
- high wear protection



## Hard Drill Head (HDH) 4-Finger for TD 73, EL D80 - Ø 130 mm

- for all mixed soils Debris,
- hard and aggressive soils
- high wear protection

Part No.: DRI 144787

## Hard Drill Head (HDH) 4-finger for TD 82 - Ø 155 mm

- for all mixed soils
- Debris, hard and aggressive soils
- high wear protection

Part No.: DRI 4811

## For side loader transmitter housing

### Hard Drill Head (HDH) 4-Finger for TD 73, EL D80 - Ø 130 mm

- for all mixed soils
- Debris, hard and aggressive soils
- high wear protection

Part No.: DRI 144787.2

### Hard Drill Head (HDH) 4-Finger for TD 82 - Ø 155 mm

- for all mixed soils
- Debris, hard and aggressive soils
- high wear protection

Part No.: DRI 4811.2

### Hard Drill Head (HDH) 4-Finger for EL D104 - Ø 180 mm

- for all mixed soils
- Debris, hard and aggressive soils
- high wear protection

Part No.: DRI 4855

# Pilot bore heads

## Round-framed chisel

Round-framed chisels are made of high-strength steel and can easily be exchanged on site with MDH pilot bore heads Type 1 2

exchangeable round-framed chisel for 4X (MDH Type 1)



Part No.: YY 246536

exchangeable round-framed chisels for TD 61, EL D67 (MDH Type 2)

exchangeable round-framed chisels for TD 61, TD 73, EL D67, EL D80 (MDH Type 1)



Part No.: YY 294481

exchangeable round-framed chisels for TD 73, EL D80 (MDH Typ 2)



Part No.: YY 246741

exchangeable round-framed chisels for TD 82 (MDH Type 1 and 2) Ø 150mm

Part No.: YY 246736

exchangeable round-framed chisels for TD 82, EL 95, EL D104 (MDH Type 1) Ø 190 mm

Part No.: YY 246870



# Pilot bore heads

## Round-framed chisels with hardened layer

Round-framed chisels are made of high-strength steel and coated with Wolframcarbid.  
They can easily be exchanged on site with MDH pilot bore heads Type 1 2

exchangeable round-framed chisels with hardened layer for TD 61,  
EL D67 (MDH Type 2)



Part No.: YY 246744.1

exchangeable round-framed chisels with hardened layer for TD 61, TD  
73, EL D67, EL D80 (MDH Type 1)



Part No.: YY 294481.1

exchangeable round-framed chisels with hardened layer for TD 73,  
EL D80 (MDH Type 2)



Part No.: YY 246741.1

exchangeable round-framed chisels with hardened layer for TD 82

Part No.: YY 246736.2

exchangeable round-framed chisels with hardened layer for TD 82, EL  
95, EL D104 (MDH Type 1)



Part No.: YY 246870.1

# Sonde housings

Sonde housings Version B with plastic inner sleeve – reinforced model. for sealing the sonde before rinsing the bore. Rigid construction made of high-quality material for quick bore head assembly on site.



Sonde housing EL D67 - Ø 75 mm, for standard sondes



Part No.: DRI 076100

Sonde housing EL D67 - Ø 75 mm, for long sondes and cable sondes

Part No.: DRI 076110

Sonde house EL D80 - Ø 85 mm, for standard sondes

Part No.: DRI 076200

Sonde housing EL D80 - Ø 85 mm, for long sondes and cable sondes

Part No.: DRI 076210

Sonde housing 4X - Ø 65 mm, for standard sondes without buffer

Part No.: DRI 094020

Sonde housing TR 34 /HIT - Ø 65 mm

Part No.: DRI 4013.5

Sonde housing RD 49 - Ø 70 mm

Part No.: MJET 4013.7

Sonde housing TD 48 - Ø 65 mm

Part No.: DRI 094010

Sonde housing TD 61 - Ø 75 mm, for standard sondes (15XP)

Part No.: DRI 074010.7

Sonde housing TD 61 - Ø 75 mm, for Eclipse cable sondes + EXL sondes, long version (15XP)

Part No.: DRI 074010.9

Sonde housings TD 73 - Ø 85 mm, for standard sonde housings

Part No.: DRI 144023

Sonde housing TD 73 -- Ø 85 mm, for Eclipse cable sondes + EXL sondes, long version

Part No.: DRI 144024

Sonde housing TD 82, for Eclipse cable sondes + EXL sondes, long version

Part No.: DRI 064018

Sonde housing TD 82, incl. facility for cable-guided bores

Part No.: DRI 064015

# Sonde housings

## Side loader Sonde housing TD 73 -- Ø 85 mm, for standard (15") sondes

Side loader sonde housing with plug-in connection for the drill head. The drill head does not have to be dismantled to remove the locating sonde.



Part No.: DRI 144028

## Side loader Sonde housing TD 82 -- Ø 100 mm, for standard (15") sondes

Side loader sonde housing with plug-in connection for the drill head. The drill head does not have to be dismantled to remove the locating sonde.

Part No.: DRI 064056

## Side loader Sonde housing TD 82 - Ø 100 mm, for long (19") sondes

Side loader sonde housing with plug-in connection for the drill head. The drill head does not have to be dismantled to remove the locating sonde.

Part No.: DRI 064057

## Side loader Sonde housing EL D104 - Ø 110 mm, for standard probes

Part No.: DRI 030020

## Side loader Sonde housing EL D104 - Ø 110 mm, for long sondes and cable sondes

Part No.: DRI 030021

# Quick-Connector

For quick and easy connection/loosening of the drilling tool to/from the drill rod.  
A return valve which prevents infiltration of soil particles, is built as a standard.

## Quick-Connector

Quick coupling-plug connection with return valve (which prevents soil particles entering during the drill rod exchange)

- For quick and easy connection/loosening of the bore tool from drill rod (even in the tightest jobsite pits)
- time consuming loosening process with heavy pipe clamps is not necessary

Incl. 2 tool adapters, 1 drill rod adapter plus 1 x 10 heavy duty lock pins

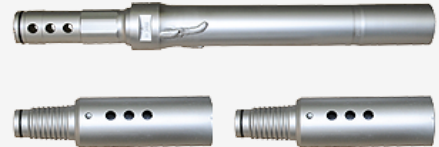

### [Quick Connector TD 61 - complete](#)

without tools

Part No.: DRI 249175

### [Quick Connector TD 73 - complete](#)

without tools

Part No.: DRI 249176

### [Quick Connector TD 82 - complete](#)

without tools

Part No.: DRI 249177

### [Quick Connector EL 95 - complete](#)

without tools

Part No.: DRI 249997

### [Quick-Connector 4X - complete](#)

without tools

Part No.: DRI 249293

### [Quick-Connector EL D67 - complete](#)

without tools

Part No.: DRI 247583

### [Quick-Connector EL D80 - complete](#)

without tools

Part No.: DRI 247586

# Quick-Connector

Loosening tool

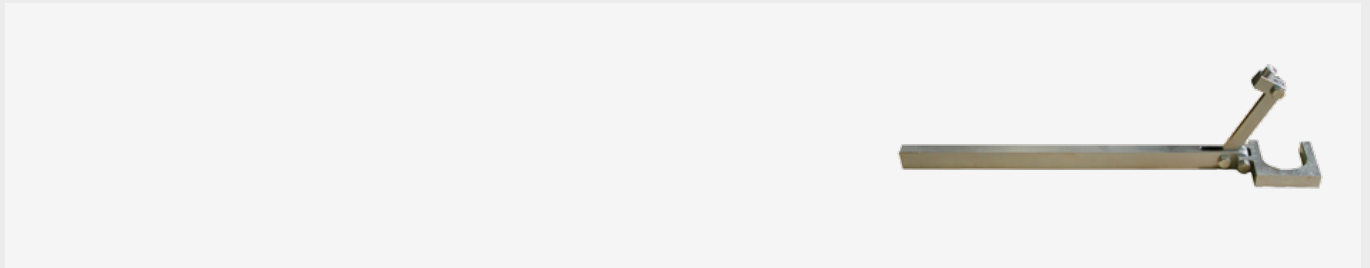

Loosening tool TD 61, EL D67

Part No.: YY 298570

Loosening tool TD 61, EL D67

Part No.: YY 298570

Loosening tool TD 73, EL D80

Part No.: YY 298672

Loosening tool TD 82 / EL 95

Part No.: YY 298566

# Quick-Connector

## Pin puncher tool

for easy removal of the lock pins

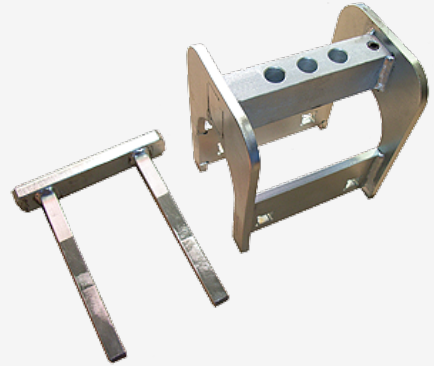

Pin puncher tool TD 61, EL D67

Part No.: YY 298718

Pin puncher tool TD 73, EL D80

Part No.: YY 298729

Pin puncher tool TD 82 / EL 95

Part No.: YY 298733

## Tool adapter, single



Tool adapter TD 61 SW 51

Part No.: YY 249022

Tool adapter TD 73 SW 59

Part No.: YY 249084

Tool adapter TD 82 / EL 95 SW 75

Part No.: YY 249017

Tool adapter 4X SW 38

Part No.: YY 309501

Tool adapter EL D67 SW 51

Part No.: YY 247568

Tool adapter EL D80 SW 59

Part No.: YY 247572

Tool adapter 2 ?" API.Reg. Pin SW 75

Part No.: YY 249336

# Quick-Connector

Drill rod adapter, single



Drill rod adapter, TD 61 SW 51	Part No.: YY 249170
Drill rod adapter, TD 73 SW 59	Part No.: YY 249172
Drill rod adapter, TD 82 SW 75	Part No.: YY 249174
Drill rod adapter, EL 95 SW 75	Part No.: YY 249960
Drill rod adapter, 4X SW 38	Part No.: YY 249292
Drill rod adapter, EL D67 SW 51	Part No.: YY 247571
Drill rod adapter, EL D80 SW 59	Part No.: YY 247576

Spare lock pins, pack with 10 pins

Spare lock pins TD 61, EL D67	Part No.: YY 249244
Spare lock pins TD 73, EL D80	Part No.: YY 249245
Spare lock pins TD 82 / EL 95	Part No.: YY 249246
Spare lock pins 4X	Part No.: YY 249311

# Drill rods

The only drill rod permitted for GRUNDODRILL

- made of high quality, flexible special steel
- soft, flowing blending into the swaged pipe end
- L 3.000 mm (effective length)
- swaged and friction welded connections
- higher resistance, higher wear reserves, longer service life than comparable drill rods
- improved clamping jaw rest (longer clamping area)
- based on many years of experience
- up to 40% lower loosening period, less sensitive to dirt



## Drill rods for GRUNDODRILL ACS 130

Drill rods 3 m (9,84 ft)

Part No.: DRI 235011

## Drill rods for GRUNDODRILL JCS 130

Drill rods 3 m (9,84 ft)

Part No.: DRI 243953

## Drill rods for GRUNDODRILL 4X

Drill rods 1,525 m (5 ft)

Part No.: DRI 249117

## Drill rods for GRUNDODRILL 7X

TwinDrive Drill rods TD 48

Part No.: DRI 294113

## Drill rods for GRUNDODRILL 7Xplus, 10S, 13/15X, 12/15GS, 10XP/15XP

TwinDrive Drill rods TD 61

Part No.: DRI 249006

## Drill rods for GRUNDODRILL 10S, 13/15X, 12/15GS

Drill rods RD 49

Part No.: DRI 249010

## Drill rods for GRUNDODRILL 15X, 15S, 15GS

TwinDrive Drill rods TD 61 strengthened

Part No.: DRI 249005

## Drill rods for GRUNDODRILL 15N

TwinDrive Drill rods TD 73

Part No.: DRI 249055



# Drill rods

Twin-tube drill rods for GRUNDODRILL 18ACS  
Twin-tube drill rods EL 95



Part No.: DRI 232843

Impact drill rods for GRUNDODRILL 20S / 25N / 28Nplus  
TwinDrive impact drill rods TD 82

Part No.: DRI 249007

## Abstreifscheiben

Abstreifscheiben zur Reinigung von Gestängen. Abstreifscheiben lassen sich einfach auf das Gestänge setzen ohne dieses zu entschrauben.

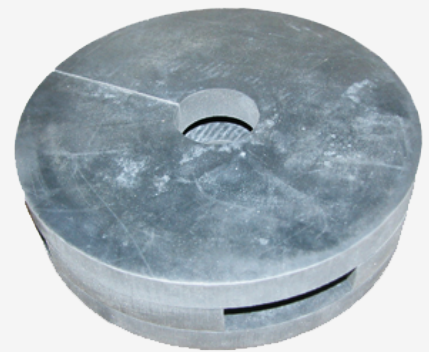

Strip-off disc for TD 48

Part No.: YY 298322

Strip-off disc for TD 61

Part No.: YY 298319

Strip-off disc for TD 73

Part No.: YY 298320

Strip-off disc for TD 82

Part No.: YY 298321

Strip-off disc for EL 95

Part No.: YY 298323

# Backreamers

Tools for expanding the pilot bore

Due to the variety of soils there is a wide range of backreamers available to ensure the best possible bore progress.

Thus TT offers various backreamers to be perfectly equipped even for rock bores. We also construct custom-made backreamers. Please contact us.

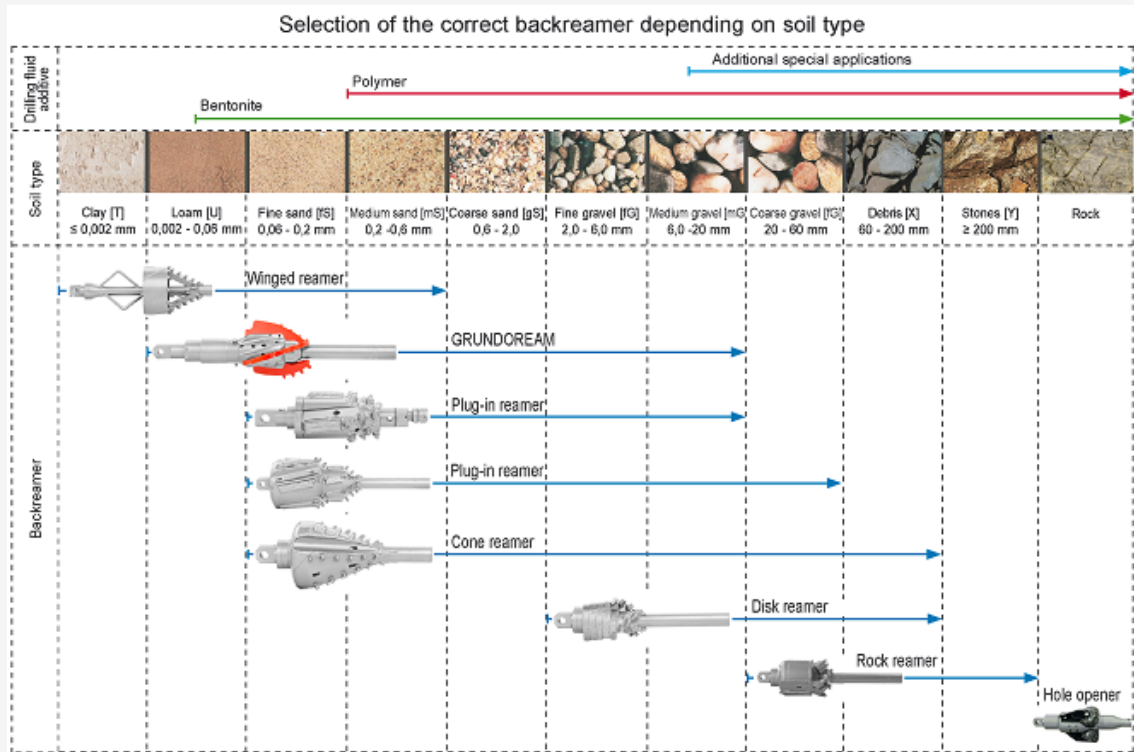

# Backreamers

## HSR Meißelreamer

- sehr schneller und leichter Werkzeugwechsel, Bohrkopf raus, Backreamer rein (Stecksystem)
- Zeitersparnis, gerade bei kleinen Rohrgrößen von Ø 40 bis 110 mm und sehr beengten Baugruben
- einsetzbar nur mit verstärktem Sendergehäuse
- mit unterschiedlichen Besätzen
- mit integriertem Drehwirbel

Weitere Ø auf Anfrage erhältlich

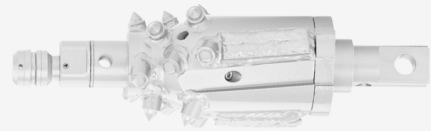

Plug-in Reamer Ø 120 mm, Burls, for sonde housing Ø 65-75 mm

Part No.: DRI 4BAAS1B

Plug-in Reamer Ø 130 mm, Sharkbit, for sonde housing Ø 65-75 mm

Part No.: DRI 4BAAS1E

Plug-in Reamer Ø 125 mm, Burls, for sonde housing Ø 85 mm

Part No.: DRI 4BAAS2B

Plug-in Reamer Ø 140 mm, Weld-on claw, for sonde housing Ø 100 mm

Part No.: DRI 4BAAS3F

Plug-in Reamer Ø 175 mm, Sharkbit - For EL D104 sonde housing

Part No.: DRI 4BBCS4H

# Backreamers

Soft-Soil-Reamer (SSR) for clay, loam, silt, marl  
Winged Reamer / Flycutter

Cutter and pre-cutter - ideal for easy to cut and hardly displaceable soils (e.g. clay and loam) as well as for bores with little coverage, requires only little torque, optimum fragmentation of the spoil due to rear paddle. Starting drill rod upon choice (e.g. API, Ditch Witch, Vermeer, TRACTO-TECHNIK)

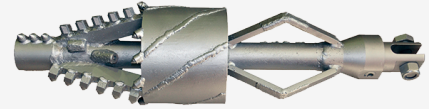

Part No.: siehe Tabelle

DB	S	B	02	03	350
not variable		not variable			
					Cutting diameter
					250
					300
					350 ←
					400
					450
					500
					550
					600
					03= Lock pin stud retainer ←
					14= Swivel 5 t welded on
					17= Swivel 15 t welded on
					16= Swivel 30 t welded on
					13= Swivel 12 t for lock pin stud
					07= Tr34 Pit
					13= TPV 4X
					02= TD61 ←
					09= TD73
					03= TD82
					15= EL D95
					16= 2 3/8"API.IF. Box
					17= 2 7/8"API.IF. Box short
					18= 2 7/8"API.Reg. Box
					19= 3 1/2"API.Reg. Box
					20= EL51 Pit 6V
					22= 8-kt. Nippel für Elicon 51
					23= EL D67
					24= EL D80
					25= EL D86
					26= 2 3/8"API.Reg. Short
					27= EL D104
					C= exchangeable round-framed chisel
					E= Sharkbit Sharkbit (weld-on tooth round)
					S= Weld-on claw "Standard" ←
<b>Order example:</b> SSR Winged reamer Ø 350 with weld-on claw, lock pin stud retainer and drill rod connection TD61					
<b>DB SB0203350</b>					

# Backreamers

Medium-Soil-Reamer (MSR) for fine sand to medium gravel soils  
Stepped Reamer

- 2-stage construction (from basic body Ø 273) for very easy and centred run and optimum smoothing of the bore channel
- Optimum jet nozzle geometry for loosening and transporting the bore spoil
- Suitable for almost all types of soil
- extremely durable, robust and low-wear construction
- Also available with integrated swivel
- Due to the two-stage construction a certain degree of centring is achieved in the upsized bore hole
- Due to the long cylindrical part at the rear of the backreamer the bore channel is well smoothed; in case of a reaming operation for cleaning the backreamer won't leave the bore channel. Due to this stabilizing part
- Conveyor nut for optimum transport of the bore spoil
- Starting drill rod upon choice (e.g. API, Ditch Witch, Vermeer, TRACTO-TECHNIK)



Part No.: siehe Tabelle

Part number system for MSR Stepped Reamer

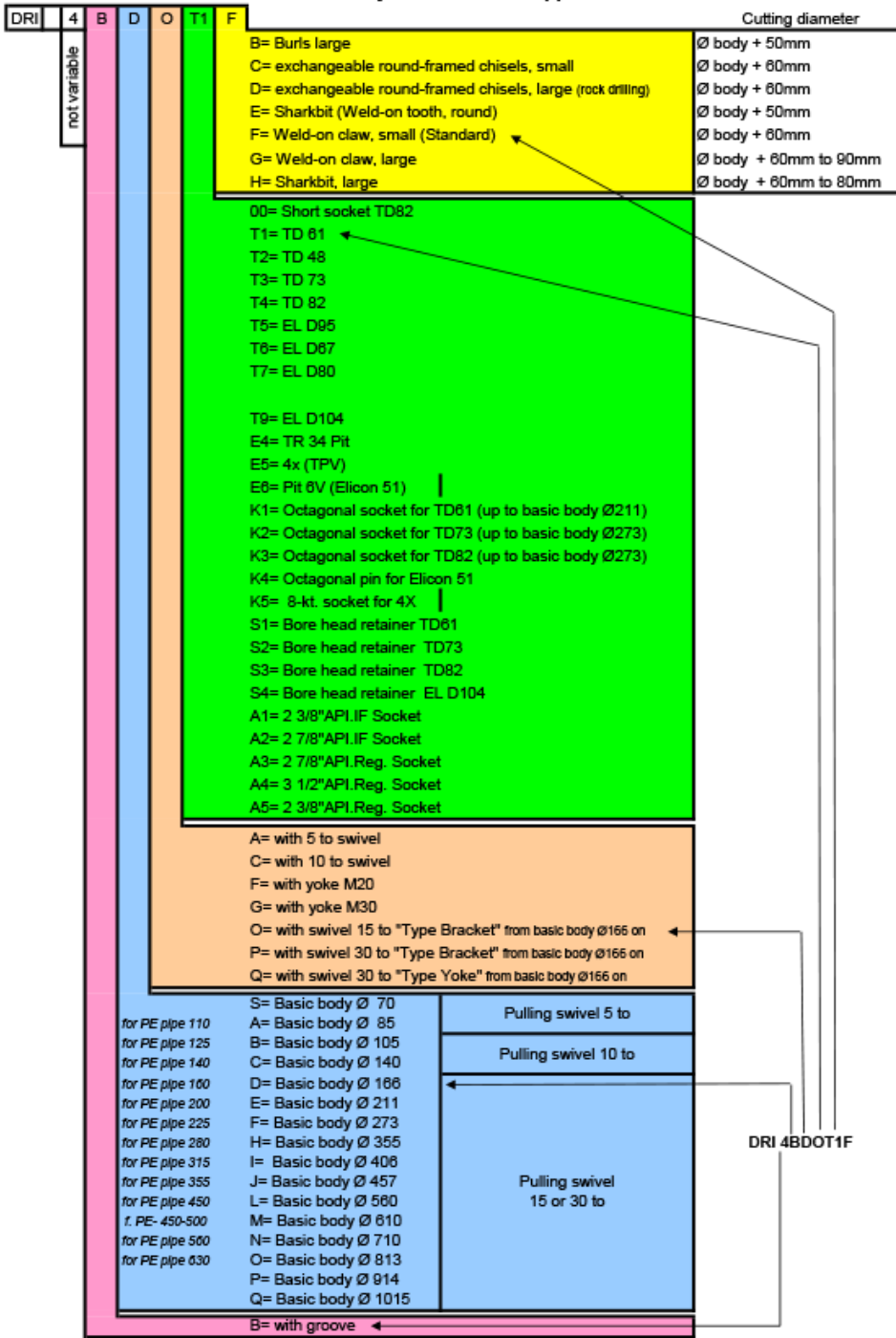

Order example: Backreamer Ø225 with weld-on claw, groove and internal swivel, rods TD81

# Backreamers

Medium-Soil-Reamer (MSR) for fine sand up to medium gravel soils  
Cone Reamer

- conical backreamer with conveyor groove
- available with internal swivel
- optimum jet nozzle position
- applicable in mixed soils up to debris, stabilizing effect due to design
- Starting drill rod upon choice (e.g. API, Ditch Witch, Vermeer, TRACTO-TECHNIK)



Part No.: siehe Tabelle

DB	S	D	02	13	325
not variabel	for cone reamer				
Cutting diameter					
(170) 220 (Swivel 30 t possible)					
(219) 270 (Swivel 30 t possible)					
(273) 325 (Swivel 30 t possible)					
(355) 405 (Swivel 30 t possible)					
(406) 455 (Swivel 30 t possible)					
(450) 500 (Swivel 30 t possible)					
(550) 600 (Swivel 30 t possible)					
(650) 700 - 750 (Swivel 30 t possible)					
(750) 800 - 850 (Swivel 30 t possible)					
14= Swivel 5 t					
17= Swivel 15 t					
16= Swivel 30 t					
13= 4X TPV					
02= TD61					
09= TD73					
10= TD82 short					
03= TD82					
08= 8-kt. Box for TD61					
15= EL D95					
16= 2 3/8"API.IF. Box					
17= 2 7/8"API.IF. Box					
18= 2 7/8"API.Reg. Box					
19= 3 1/2"API.Reg. Box					
20= EL51 Pit 6V					
22= 8-kt. pin for Elicon 51					
23= EL D67					
24= EL D80					
25= EL D86					
26= EL D104					
K2= 8-kt. box for TD73					
E= Sharkbit (Weld-on tooth, round)					
S= Weld-on claw with hard metal plate					

Order example: Cone reamer Ø325 with Sharkbit, swivel 15 to, drill rod connection TD61

DB ED0217325

# Backreamers

Medium-Soil-Reamer (MSR) for fine sand up to medium gravel soils  
Grundream

- Backreamer body with exchangeable cutting blades for varying the upsizing diameter
- distinctively reduced torque due to optimum blade geometry
- excellent cutting effect with high spoil discharge
- hardly any wear at the basic body
- optimum jet nozzle geometry for good back flow prevents conglutinating of the blades
- Starting drill rod upon choice (e.g. API, Ditch Witch, Vermeer, TRACTO-TECHNIK)

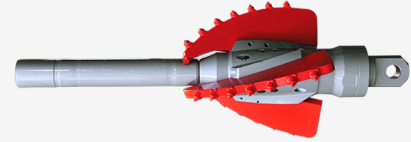

Part No.: nach Tabelle

DB	05	07	11
not variable			
			01= Yoke M20 02= Yoke M30 05= Swivel 12 t, attached (only with Ø 100) 10= Integrated swivel 12 to (only with Ø 190) 11= Integrated swivel 30 to (only with Ø 190)
			01= TD48 02= TD61 03= TD82 04= Rd49 07= TD73 08=without pulling rod 09= 2 3/8" API.IF Box 10= 2 7/8" API.IF Box 11= 2 7/8" API.Reg Box 12= 3 1/2" API.Reg. Box 13= EL51 Pit 6V 14= 8-kt. Nippel für Elicon 51 15= EL D67 16= EL D80 17= EL D86 18= EL D104
			04= Grundream 1, Ø100 for bores Ø150 - Ø250mm 05= Grundream 2, Ø190 for bores Ø200 - Ø550mm

**Order example:** Grundream 2, drill rod connection TD73, swivel 30 tons

DB 050711



# Backreamers

## Sharkbit Blade set

Blade set for sandy, clay soils up to mixed corn soils  
Blade set consisting of 3 blades

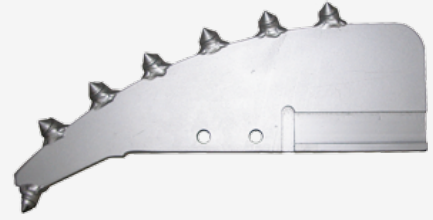

Sharkbit Ø 150 mm (Basic body I)	Part No.: DB 01M150B01
Sharkbit Ø 200 mm (Basic body I)	Part No.: DB 01M200B01
Sharkbit Ø 250 mm (Basic body I)	Part No.: DB 01M250B01
Sharkbit Ø 200 mm (Basic body II)	Part No.: DB 02M200B01
Sharkbit Ø 250 mm (Basic body II)	Part No.: DB 02M250B01
Sharkbit Ø 300 mm (Basic body II)	Part No.: DB 02M300B01
Sharkbit Ø 350 mm (Basic body II)	Part No.: DB 02M350B01
Sharkbit Ø 400 mm (Basic body II)	Part No.: DB 02M400B01
Sharkbit Ø 450 mm (Basic body II)	Part No.: DB 02M450B01
Sharkbit Ø 500 mm (Basic body II)	Part No.: DB 02M500B01
Sharkbit Ø 550 mm (Basic body II)	Part No.: DB 02M550B01
Claw cutter Ø 350 mm (Basic body II)	Part No.: DB 02M350F01
Claw cutter Ø 400 mm (Basic body II)	Part No.: DB 02M400F01
Claw cutter Ø 450 mm (Basic body II)	Part No.: DB 02M450F01
Claw cutter Ø 500 mm (Basic body II)	Part No.: DB 02M500F01

# Backreamers

Hard-Soil-Reamer (HSR) for coarse gravel mixed soils, debris, hard and aggressive soils  
Disc Reamer

Aggressive backreamer for very compact and hard soils

- for weathered rock
- extremely wear-resistant
- good mixing of the spoil with the drilling fluid
- available with internal swivel
- Diameter slightly larger than the given inch measure. That way it is possible to build the hole opener into the upsized bore
- Starting drill rod upon choice (e.g. API, Ditch Witch, Vermeer, TRACTO-TECHNIK)



8" - TD61 with swivel 15 tons

Part No.: DB SH0213203

10" - TD61 with swivel 15 tons

Part No.: DB SH0217255

12" - TD61 with swivel 15 tons

Part No.: DB SH0217305

14" - TD61 with swivel 15 tons

Part No.: DB SH0217355

16" - TD61 with swivel 15 tons

Part No.: DB SH0217405

18" - TD61 with swivel 15 tons

Part No.: DB SH0217460

8" - TD73 with swivel 15 tons

Part No.: DB SH0913203

10" - TD73 with swivel 30 tons

Part No.: DB SH0916255

12" - TD73 with swivel 30 tons

Part No.: DB SH0916305

14" - TD73 with swivel 30 tons

Part No.: DB SH0916355

16" - TD73 with swivel 30 tons

Part No.: DB SH0916405

18" - TD73 with swivel 30 tons

Part No.: DB SH0916460

8" - TD82 with swivel 15 tons

Part No.: DB SH0313203

10" TD82 with swivel 30 tons

Part No.: DB SH0316255

12" - TD82 with swivel 30 tons

Part No.: DB SH0316305

14" - TD82 with swivel 30 tons

Part No.: DB SH0316355

16" - TD82 with swivel 30 tons

Part No.: DB SH0316405

18" - TD82 with swivel 30 tons

Part No.: DB SH0316460

# Backreamers

Hard-Soil-Reamer (HSR) for coarse gravel mixed soils, debris, hard and aggressive soils  
 Rock Reamer

- Chisels can be stroke out from behind
- for very fast bore progress
- for rock up to 60 MPa
- also applicable in mixed soils and debris
- with internal swivel
- Starting drill rod upon choice (e.g. API, Ditch Witch, Vermeer, TRACTO-TECHNIK)

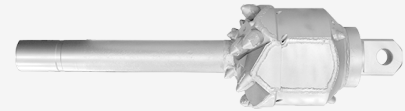

8 " (Ø 215 mm) - TD 61 with swivel 15 tons	Part No.: DRI 243508
8 " (Ø 215 mm) - TD 73 with swivel 30 tons	Part No.: DRI 243518
8 " (Ø 215 mm) - TD 82 with swivel 30 tons	Part No.: DRI 244947
20 " (Ø 525 mm) - TD 82 with swivel 30 tons	Part No.: DRI 272304
10 " (Ø 260 mm) - TD 61 with swivel 15 tons	Part No.: DRI 243510
10 " (Ø 260 mm) - TD 73 with swivel 30 tons	Part No.: DRI 243511
10 " (Ø 260 mm) - TD 82 with swivel 30 tons	Part No.: DRI 244960
10 " (Ø 260 mm) - ELD 104 with swivel 30 tons	Part No.: YY 272264
12 " (Ø 320 mm) - TD 61 with swivel 15 tons	Part No.: DRI 272308
12 " (Ø 320 mm) - TD 73 with swivel 30 tons	Part No.: DRI 272309
12 " (Ø 320 mm) - TD 82 with swivel 30 tons	Part No.: DRI 272310
12 " (Ø 320 mm) - ELD 104 with swivel 30 tons	Part No.: DRI 272311
14 " (Ø 370 mm) - TD 82 with swivel 30 tons	Part No.: DRI 248790
14 " (Ø 370 mm) - ELD 104 with swivel 30 tons	Part No.: DRI 248789
16 " (Ø 430 mm) - TD 82 with swivel 30 tons	Part No.: DRI 272326
16 " (Ø 430 mm) - ELD 104 with swivel 30 tons	Part No.: DRI 272327
18 " (Ø 457 mm) - TD 82 with swivel 30 tons	Part No.: DRI 243579
18 " (Ø 457 mm) - ELD 104 with swivel 30 tons	Part No.: DRI 248783
20 " (Ø 525 mm) - TD 82 with swivel 30 tons	Part No.: DRI 272304
20 " (Ø 525 mm) - ELD 104 with swivel 30 tons	Part No.: DRI 272306
20 " (Ø 525 mm) - ELD 104 with swivel 30 tons	Part No.: DRI 272306
20 " (Ø 525 mm) - ELD 104 with swivel 30 tons	Part No.: DRI 272306
20 " (Ø 525 mm) - ELD 104 with swivel 30 tons	Part No.: DRI 272306

Tool disassembly of the chisels 12" - 26"

Tool for removing the chisels from the 12" to 26" rock reamers

Part No.: DRI 272306

Backreamer-Zubehör

Sharkbit, Height: 25 mm - Width: 20 mm

Applied in firmly layered non-cohesive soils



Part No.: 220910863

Sharkbit, height 49 mm - width 25 mm

Applied in firmly layered non-cohesive soils



Part No.: 229800188

Round-framed chisel, 14 mm

Standard fitting for cohesive, non-cohesive and standard layered soils. Applied when increasing the free-cutting size. Shaft diameter: 14 mm



Part No.: 229800214

Chisel retainer for shaft diameter 14 mm

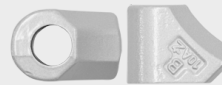

Part No.: 229800214.01

Round-framed chisel, 20 mm

Standard fitting for cohesive, non-cohesive and standard layered soils. Applied when increasing the free-cutting size. Shaft diameter: 20 mm



Part No.: 229800189

Chisel retainer for shaft diameter 20 mm

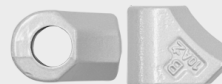

Part No.: 229800190

# Backreamers

## Round-framed chisel, 25 mm

Standard fitting for cohesive, non-cohesive and standard layered soils. Applied when increasing the free-cutting size. Shaft diameter: 25 mm



Part No.: 229800257

## Chisel retainer for shaft diameter 25 mm



Part No.: 229800193

## Weld-on claw, Height: 27 mm - Width: 20 mm

Application in firmly layered up to sandy soils. Good protection of the shaft due to especially stable hard metal plate. Height: 27 mm, Width: 20 mm

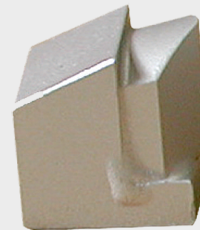

Part No.: YY 284629

## Weld-on claw, Height: 45 mm - Width: 20 mm

Application in cohesive up to non-cohesive soils and in standard layered soils with increased sand content. Applied for increasing the free-cutting size. Height: 45 mm, Width: 20 mm

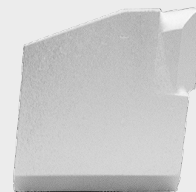

Part No.: 220960301

## Weld-on claw, Height: 65 mm - Width: 20 mm

Application in cohesive up to non-cohesive soils and in standard layered soils with increased sand content. Applied for increasing the free-cutting size. Height: 65 mm, Width: 20 mm



Part No.: 220910868

## Guiding sleeve with weld-on burls

as a wear and tear protection for the basic body, displacing tool



Part No.: Auf Anfrage

## Spare chisel for Rock Reamer 8" and 10"



Part No.: YY 246736

## Replacement-chisel for Rock Reamer 12", 14" and 16"



Part No.: 229800184

# Swivels

The swivel connects the backreamer to the pipe to be pulled in.  
All swivels have an integrated thrust bearing which enables pushing back of the backreamer..

Swivel - screw version 5t Thread M55

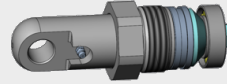

Part No.: YY 242804

Swivel - screw version 10t Thread M70

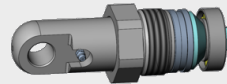

Part No.: YY 249465

Swivel - bolt-on version 15t Thread 8 x M16

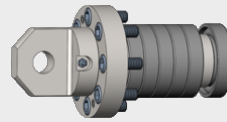

Part No.: DRI 064209

Swivel - bolt-on version 15t Thread 3 x M16

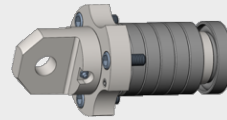

Part No.: DRI 064209D

Swivel - bolt-on version 30t Thread 8 x M16

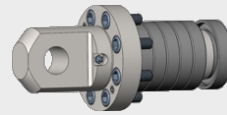

Part No.: DRI 064209B

Swivel - Bracket - Bracket 5 tons



Part No.: YY 247816

Swivel 3 1/2" API.Reg 5 tons

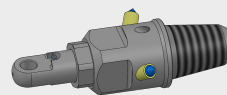

Part No.: YY 247825

Swivel Flange - Tension Pin Shaft 12 ton Swivel

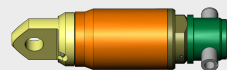

Part No.: DRI 064211

# Push heads

For simple insertion into the bore channel after intermediate reaming.

## Thrust/Push head (light-weight build)

- for simple pushing into the bore channel after intermediate reaming
- no need for screwing and pulling of drill rods
- no canting inside the bore channel



Thrust/Push head 4X - Ø 114 mm

Part No.: YY 246828

Thrust/Push head RD 49 - Ø 140 mm

Part No.: YY 246689

Thrust/Push head TD 48 - Ø 140 mm

Part No.: YY 246690

Thrust/Push head TD 61 - Ø 140 mm

Part No.: YY 246764

Thrust/Push head TD 73 - Ø 120 mm

Part No.: YY 246849

Thrust/Push head TD 73 - Ø 170 mm

Part No.: YY 246694

Thrust/Push head TD 73 - Ø 170 mm

Part No.: YY 246949

Thrust/Push head TD 82 - Ø 170 mm

Part No.: YY 246695

Thrust/Push head EL D80 - Ø 140 mm

Part No.: YY 247612

Thrust/Push head EL D95/101 - Ø 140 mm

Part No.: YY 246897

Thrust/Push head TD 82 - Ø 170 mm

Part No.: YY246695 + YY249456

# Push heads

## Schub/Pushkopf mit Steuerfläche

- direkter Anschluss ans Sendergehäuse
- steuerbar bei eventuell zusammengefallenem Bohrkanal



Thrust/Push head with steering surface TD 61 - Ø 140 mm

Part No.: YY 246658

Thrust/Push head with steering surface TD 73 - Ø 140 mm

Part No.: YY 246746

Thrust/Push head with steering surface TD 82 - Ø 170 mm

Part No.: YY 246769

Thrust/Push head with steering surface EL D104 - Ø 170 mm

Part No.: YY 246953



# Pipe pullers

Pipe pullers and cutting nipples for the secure connection between the rotary swivel and the PE product pipe.

## Pipe pullers

Pipe pullers connect swivel and the PE product pipe to be installed. Pipe-pullers are used for pulling in pipes. TT-pipe pullers adapt automatically to the standard pressure steps of the relevant pipe. For all conventional HDPE/PP pipes from OD 25 mm on, extremely tight and optionally available with rear seal and yoke (upon request) PE reducing adapter available upon request.

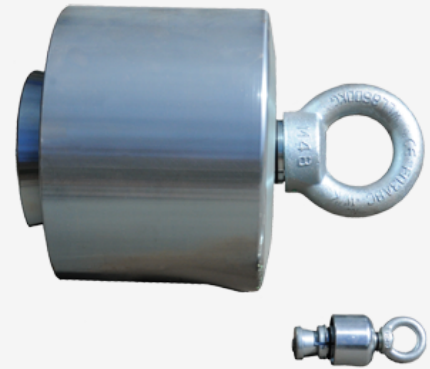

Pipe puller Ø 25 mm	Part No.: GMO 2380R
Pipe puller Ø 32 mm	Part No.: GMO 2390R
Pipe puller Ø 40 mm	Part No.: GMO 2400R
Pipe puller Ø 50 mm	Part No.: GMO 2410R
Pipe puller Ø 63 mm	Part No.: GMO 2420R
Pipe puller Ø 75 mm	Part No.: GMO 2430R
Pipe puller Ø 90 mm	Part No.: GMO 2440R
Pipe puller Ø 110 mm	Part No.: GMO 2450R
Pipe puller Ø 125 mm	Part No.: GMO 2460R
Pipe puller Ø 140 mm	Part No.: GMO 2470R
Pipe puller Ø 160 mm	Part No.: GMO 2480R
Pipe puller Ø 180 mm	Part No.: GMO 2490R
Pipe puller Ø 200 mm	Part No.: GMO 2710R
Pipe puller Ø 225 mm	Part No.: GMO 2720R
Pipe puller Ø 250 mm	Part No.: GMO 2730R
Pipe puller Ø 280 mm	Part No.: GMO 2760R

# Pipe pullers

Pipe puller Ø 315 mm

Part No.: GMO 2740R

Pipe puller Ø 355 mm

Part No.: GMO 2750R

Pipe puller Ø 400 mm

Part No.: GMO 2770R

Pipe puller Ø 450 mm

Part No.: GMO 2780R

Pipe puller Ø 500 mm



Part No.: GMO 2790R

Seal kits for Pipe puller

Ringspreiznippel Art.-Nr.	Rohrdrn. mm	Dichtringsatz Art.-Nr.
GMO 2380R	25	DRI 243238
GMO 2390R	32	DRI 243219
GMO 2400R	40	DRI 243220
GMO 2410R	50	DRI 243221
GMO 2420R	63	DRI 243222
GMO 2430R	75	DRI 243223
GMO 2440R	90	DRI 243224
GMO 2450R	110	DRI 243225
GMO 2460R	125	DRI 243226
GMO 2470R	140	DRI 243227
GMO 2480R	160	DRI 243228
GMO 2490R	180	DRI 243229
GMO 2710R	200	DRI 243230
GMO 2720R	225	DRI 243231
GMO 2730R	250	DRI 243232
GMO 2760R	280	DRI 243233
GMO 2740R	315	DRI 243234
GMO 2750R	355	DRI 243235
GMO 2770R	400	DRI 243236
GMO 2780R	450	DRI 243236
GMO 2790R	500	DRI 243237

Part No.: see table below

Required connecting elements between pipe puller with ring nut and swivel				
	Part No.	fitting shackle for pipe puller with ring nut		
		Swivel I	Swivel II und 12t new	Swivel II PLUS
ø 40	GMO 2400	1515016001 + 1599000040 or 2 x 1515016001	1515016001 + 1515010002	2 x 1515016001 + YY 294966
ø 50	GMO 2410			
ø 63	GMO 2420			
ø 75	GMO 2430			
ø 90	GMO 2440			
ø 110	GMO 2450	1515016001	1515016001 + 1515010002	1515016001 + YY 294966
ø 125	GMO 2460			
ø 160	GMO 2480	not possible	1515010002	1515010002 + YY 294966
ø 180	GMO 2490			
ø 200	GMO 2710			
ø 250	GMO 2730			
ø 280	GMO 2760			
ø 315	GMO 2740			
ø 355	GMO 2750			
ø 400	GMO 2770			
ø 450	GMO 2780			
ø 500	GMO 2790			

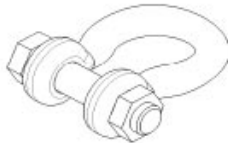
Part No. 1599000040	Designation Connecting link 2 t, nominal size 8-8	
1515016001	Shackle 5 t (forged shape)	
1515010002 1515114001	High-strength cambered shackle 1", 8.5 t / 6-fold security High-strength cambered shackle 1 1/4", 12 t / 6-fold security	
YY 294966	Universal joint for swivel type III	

Part No.: see table below

# Pipe pullers

## Cutting nipples (incl. rear seal)

Pipe pullers connect swivel and the PE product pipe to be installed.  
Cutting nipples are screwed into the pipe.



Cutting nipple Ø 32 - 40 mm OD

Part No.: PIT 4202.1

Cutting nipple Ø 50 mm OD

Part No.: PIT 4202.2

Cutting nipple Ø 63 mm OD

Part No.: PIT 4202.3

### Multi-pulling device

...depending on task, also with chain members.

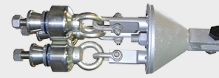

Part No.: auf Anfrage

Cable Pulling Sock 30 - 40mm



Part No.: 1535300003

Cable Pulling Sock 40 - 50mm

Part No.: 1535400001

Cable Pulling Sock 50 - 60mm

Part No.: 1535500002

# Pipe pullers

## Pulling Eyes

Special adapter for pulling in drill rods during intermediate reamings for all TT threadings



Pulling eye Socket TD 61



Part No.: DRI 294656

Pulling eye Socket TD 73

Part No.: DRI 249074

Pulling eye Socket TD 82

Part No.: DRI 294101

Pulling eye Socket Elicon 95

Part No.: DRI 249964

Pulling eye Socket EL D67

Part No.: YY 249349

Pulling eye Socket EL D80

Part No.: YY 249385

Pulling eye Socket Elicon 95

Part No.: DRI 249452

Pulling eye Nipple 4X



Part No.: DRI 249038

Pulling eye Nipple TD 61

Part No.: DRI 294658

Pulling eye Nipple TD 73

Part No.: DRI 249075

Pulling eye Nipple TD 82

Part No.: DRI 294100

Pulling eye Nipple Elicon 95

Part No.: DRI 249966

Pulling eye Nipple Elicon 95

Part No.: YY 249350

Pulling eye Nipple Elicon 95

Part No.: YY 249386

Pulling eye Nipple Elicon 95

Part No.: DRI 249455

## PE Welding head

for pulling in PE pipes



PE Welding head DA 63	Part No.: DRI 243261
PE Welding head DA 75	Part No.: DRI 243262
PE Welding head DA 90	Part No.: DRI 243263
PE Welding head DA 110	Part No.: DRI 243264
PE Welding head DA 125	Part No.: DRI 243265
PE Welding head DA 140	Part No.: DRI 243266
PE Welding head DA 160	Part No.: DRI 243267
PE Welding head DA 180	Part No.: DRI 243268
PE Welding head DA 200	Part No.: DRI 243269
PE Welding head DA 225	Part No.: DRI 243270
PE Welding head DA 250	Part No.: DRI 243271
PE Welding head DA 280	Part No.: DRI 243272
PE Welding head DA 315	Part No.: DRI 243273
PE Welding head DA 355	Part No.: DRI 243274
PE Welding head DA 400	Part No.: DRI 243275
PE Welding head DA 450	Part No.: DRI 243276
PE Welding head DA 500	Part No.: DRI 243277
PE Welding head DA 560	Part No.: BUR S204210

# Rock drilling technique

Special drilling tools for penetrating rock

## Grundorock

Mud motors for rock drilling.

Special sonde housing with thread adapters for various drill rod types are available.

The mud motors can be hired out.

Contact: René Schrinner at+ 49 2723 9155-429



[Fact sheet rock drilling](#)

### Grundorock 2 7/8 "

Available with bending 1,75° and 2,0°

Part No.: auf Anfrage

### Grundorock 3 3/4 "

Available with bending 1,75°, 2,0° and 2,25°

Part No.: auf Anfrage

## Sonde housings for Grundorock

Rock drilling sonde housings 2 7/8 " Mud-Motor, TD 82 - Ø 83 mm, for standard sondes

Part No.: DRI 064097

Rock drilling sonde housings for 2 7/8 " Mud Motor, TD 82 - Ø 83 mm, for long sondes

Part No.: DRI 064105

Rock drilling sonde housings for 3 3/4 " Mud-Motor, TD 82 - Ø 95 mm, for standard sondes

Part No.: DRI 064046

Rock drilling sonde housings for 3 3/4 " Mud-Motor, TD 82 - Ø 95 mm, for long sondes

Part No.: DRI 064106

## Rock drilling unit for twin-tube rods EL D80

- 
- Integrated transmitter housing
- 2 7/8" API REG holders for roller and PDC chisels



[Rock Drilling Unit for Double Rod Casing EL D80](#)

Part No.: DRI 233999

[Extension for Rod Connection](#)

Part No.: YY 248631

## Rock drilling unit for twin-tube rods EL D95

- integrated sonde housing
- 3 1/2" API REG retainer for roller and PDC chisel
- further angles up to max. 2,5° upon request



### Rock Drilling Unit V1 with 2.25° Angulation

For Digi Trac and Radiodetection Probes

Part No.: DRI 232810

### Rock Drilling Unit V1 with 2.5° Angulation

For Digi Trac and Radiodetection Probes

Part No.: DRI 232959

### Rock Drilling Unit V3

For Digi Trac and Radiodetection Probes

Part No.: DRI 232959

### Rock drilling unit with bending 2,25°

for cable-guided bores

Part No.: DRI 232883

### Extension for Rod Connection

Part No.: YY 248595

### Rock drilling unit for twin-tube rods EL D101

For 15° and 19° Probes

3 1/2" API Reg Socket for Roller Cone Bits

Part No.: DRI 249477

## Rock drilling unit for twin-tube rods

- integrated sonde housing
- 3 1/2" API REG retainer for roller and PDC chisel
- further angles up to max. 2,5° upon request



### Rock drilling unit for twin-tube rods EL D104

For 15° and 19° Probes

3 1/2" API Reg Socket for Roller Cone Bits

Part No.: DRI 248677

### Extension for linkage connection for double tube linkage EL D104

Part No.: YY248698



# Rock drilling technique

## Chisel for Grundorock 2 7/8 "

### Roller chisel 4 1/4 " TCI

Thread connection: 2 3/8" API.Reg.  
IADC-Code: 517  
WOB (pressure) [kg]: -5000  
Recommended rpm [1/min]: -300  
Max. rock strength [Mpa]: 190



Part No.: 229800148

### Winged chisel 4 1/4 "

Thread connection: 2 3/8" API.Reg.  
WOB (pressure) [kg]: -3000  
Recommended rpm [1/min]: -250  
Max. rock strength [Mpa]: 20



Part No.: 229800123

## Chisel for Grundorock 4 3/4 "

### PDC drill cutter bit 4 3/4"

Thread connection: 2 7/8" API.Reg.  
Formations: soft to medium-hard rock  
All PDC drill heads have small injectors.  
Application range: Soft to medium hard rock  
The drill head shall not be used to drill through rubble. If you have any questions concerning application, please contact René Schrinner, telephone number 0171 4707380.  
Advantages: double to triple heading rate in comparison to roller bits. Because the PDC drill cutter bits take a cutting action, they make better use of the steering mechanism and do not slip away as easily as roller bits while starting to drill into rock horizons at a flat angle. Damaged diamond cutting plates can be replaced.



Part No.: 229800254

### Roller chisel 4 3/4 " TCI

Thread connection: 2 7/8" API.Reg.  
IADC-Code: 547  
WOB (pressure) [kg]: -10000  
Recommended rpm [1/min]: -300  
Max. rock strength [Mpa]: 190



Part No.: 229800144

### Roller chisel 4 3/4 " Milled Tooth

Thread connection: 2 7/8" API.Reg.  
IADC-Code: 117  
WOB (pressure) [kg]: -10000  
Recommended rpm [1/min]: -300  
Max. rock strength [Mpa]: -65



Part No.: 229800198

### Winged chisel 4 3/4 "

Thread connection: 2 3/8" API.Reg.  
WOB (pressure) [kg]: -4000  
Recommended rpm [1/min]: -250  
Max. rock strength [Mpa]: 20



Part No.: 229800161

### Adapter for winged chisel 4 3/4"

Part No.: 229800162

#### Adapter for transmitter housing

The adapter allows you to mount cutter bits for the Grundorock 2 7/8" onto transmitter housings of  $\varnothing 65$  to  $\varnothing 75$ mm. The combination with these cutter bits enables loosening of incrustations etc. in old lines or short bores through bedrock without steering.



Part No.: YY 249198

#### Rock drilling chisel for GRUNDODRILL ACS 130

##### Roller chisel 5 1/2" TCI (IADC 547)

Thread connection 2 7/8" API.Reg.

IADC-Code: 547

WOB (pressure) [kg]: -16000

Recommended rpm [1/min]: 40-140

Max. rock strength [Mpa]: 190



Part No.: 229800237

##### PDC drill cutter bit 5 1/2"

Thread connection: 2 7/8" API.Reg.

Formations: soft to medium-hard rock

All PDC drill heads have small injectors.

Application range: Soft to medium hard rock The drill head shall not be used to drill through rubble. If you have any questions concerning application, please contact René Schrunner, telephone number 0171 4707380.

Advantages: double to triple heading rate in comparison to roller bits. Because the PDC drill cutter bits take a cutting action, they make better use of the steering mechanism and do not slip away as easily as roller bits while starting to drill into rock horizons at a flat angle. Damaged diamond cutting plates can be replaced.



Part No.: DRI P512542

# Rock drilling technique

## Chisel for GRUNDODRILL 18ACS and ACS 300

### Roller chisel 6 1/2 " Milled Tooth (IADC 217)

Thread connection: 3 1/2" API.Reg.

IADC-Code: 217

WOB (pressure) [kg]: -16000

Recommended rpm [1/min]: 70-150

Max. rock strength [Mpa]: 65



Part No.: DRI ZM612217

### Roller chisel 6 1/2 " TCI (IADC 547)

Thread connection: 3 1/2" API.Reg.

IADC-Code: 547

WOB (pressure) [kg]: -16000

Recommended rpm [1/min]: 40-140

Max. rock strength [Mpa]: 190



Part No.: DRI WM612547

### Roller chisel 6 1/2 " TCI (IADC 637)

Thread connection: 3 1/2" API.Reg.

IADC-Code: 637

WOB (pressure) [kg]: -16000

Recommended rpm [1/min]: 40-140

Max. rock strength [Mpa]: 290

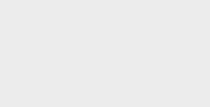

Part No.: DRI WM612637

### Roller chisel 6 1/2 " TCI (IADC 837)

Thread connection: 3 1/2" API.Reg.

IADC-Code: 837

WOB (pressure) [kg]: -16000

Recommended rpm [1/min]: 40-140

Max. rock strength [Mpa]: 345 and higher

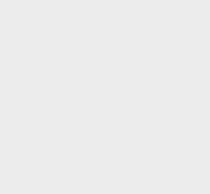

Part No.: DRI WM612837

### Winged chisel 6 1/2 "

Thread connection: 3 1/2" API.Reg.

WOB (pressure) [kg]: -6000

Recommended rpm [1/min]: -200

Max. rock strength [Mpa]: 20



Part No.: DRI SM612000

# Rock drilling technique

## PDC drilling chisel Ø 6 1/2 " with 4 wings

Thread connection 3 1/2"API.Reg.

Max. pressure 40 KN

Rotation speed: 150 - 250 min. -1

Formation: Soft rock

Alle PDC bore heads are equipped with small jet nozzles.

Application range:

- Soft to medium hard rock
- The bore head should not be used in debris
- In case of questions on the application contact René Schrinner by phone at +49 171 4707380

Advantages

- Double up to triple installation speed compared to a roller chisel
- As the PDC drilling chisel cuts through the soil, it can be steered more precisely and the danger of slipping off when drilling in a flat angle into rock horizons is reduced, as opposed to roller chisels.
- Defective diamond cutting plates can be replaced.



Part No.: DRI P612443

## PDC drilling chisel Ø 6 1/2 " with 5 wings

Thread connection 3 1/2"API.Reg.

Max. pressure 60 KN

Rotation speed: 150 - 250 min. -1

Formation: Soft to medium hard rock

Alle PDC bore heads are equipped with small jet nozzles.

Application range:

- Soft to medium hard rock
- The bore head should not be used in debris
- In case of questions on the application contact René Schrinner by phone at +49 171 4707380

Advantages

- Double up to triple installation speed compared to a roller chisel
- As the PDC drilling chisel cuts through the soil, it can be steered more precisely and the danger of slipping off when drilling in a flat angle into rock horizons is reduced, as opposed to roller chisels.
- Defective diamond cutting plates can be replaced.



Part No.: DRI P612543

# Rock drilling technique

## PDC drilling chisel Ø 6 1/2 " with 6 wings

Thread connection 3 1/2"API.Reg.

Max. pressure 60 KN

Rotation speed: 150 - 250 min. -1

Formation: Soft to medium hard rock

Alle PDC bore heads are equipped with small jet nozzles.

Application range:

- Soft to medium hard rock
- The bore head should not be used in debris
- In case of questions on the application contact René Schrinner by phone at +49 171 4707380

Advantages

- Double up to triple installation speed compared to a roller chisel
- As the PDC drilling chisel cuts through the soil, it can be steered more precisely and the danger of slipping off when drilling in a flat angle into rock horizons is reduced, as opposed to roller chisels.
- Defective diamond cutting plates can be replaced.



Part No.: DRI P612643

## Mounting wrench for jet nozzles of PDC drilling chisel

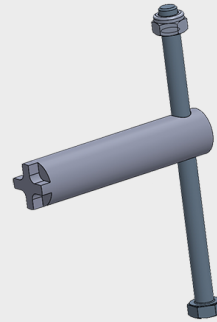

Part No.: YY 246892

# Rock drilling technique

HSR HoleOpener 2,5 "

Standard connection TD 61



HSR HoleOpener 2,5 " (basic body)  
incl. 5 tons swivel and jet nozzles

Part No.: YY 299335

Counter support set 6"

Part No.: YY 299269

Pulling rod for TD 48

Part No.: YY 294184

Pulling rod for TR 34 GRUNDODRILL

Part No.: YY 294136

Adapter for TR 34

Part No.: YY 249054

Adapter for EL 51

Part No.: YY 309557

Adapter for Quick Connect EL 51

Part No.: YY 249303

# Rock drilling technique

## HSR Hole Opener 4 "

HSR HoleOpener 4 " (Body)  
incl. 15 to swivel and jet nozzles



HSR HoleOpener 4 " (basic body)

incl. 30 tons swivel and jet nozzles

Part No.: YY 299107

8" TCI Cutter set (203.2 mm)

Counter support set for cutter is required  
up to 220 MPa

Part No.: YY 299327

10" TCI Cutter set (245 mm)

Counter support set for cutter is required  
up to 220 MPa

Part No.: YY 299325

10" TCI Cutter set (245 mm)

Counter support set for cutter is required  
up to 280 MPa

Part No.: YY 299143

Counter support set 6"

Part No.: YY 299260

Counter support set 10"

Part No.: YY 299261

Pulling rod for TD 61

Part No.: YY 294144.1

Pulling rod for TD 73

Part No.: YY 245316.1

Pulling rod for TD 82

Part No.: YY 299273

Pulling rod for 2 3/8 " API IF Box

Part No.: YY 242825

Assembly tool

Part No.: YY 299206

Holding screw for assembly tool

Part No.: YY 272317

Loosening wrench

Part No.: YY 299208

Adapter TD 82 nipple EL 95 sleeve

Part No.: YY 232608

Adapter TD 82 Nippel auf EL D80

Part No.: YY 249340

Adapter TD 82 nipple EL 95 sleeve

Part No.: YY 249456

# Rock drilling technique

## HSR Hole Opener 5,5 "



HSR HoleOpener 5,5 " (basic body)  
incl. 30 tons swivel and jet nozzles

Part No.: YY 299185

12 " TCI cutter-set (305 mm)  
up to 220 MPa

Part No.: YY 248560

12 " TCI cutter-set (305 mm)  
up to 280 MPa

Part No.: YY 299161

14 " TCI cutter-set (356 mm)  
up to 220 MPa

Part No.: YY 248561

Cutterset 14"  
up to 220 MPa

Part No.: YY 248561

16 " TCI cutter-set (406 mm)  
up to 220 MPa

Part No.: YY 248562

16" TCI Cutter set (406 mm)  
up to 280 MPa

Part No.: YY 299150

Counter support set 12"

Part No.: YY 299254

Counter support set 14"

Part No.: YY 299255

Counter support set 16"

Part No.: YY 299256

Pulling rod for 2 7/8 " API IF Box

Part No.: YY 249441

Pulling rod for TD 61

Part No.: YY 245063.1

Pulling rod for TD 73

Part No.: YY 245317.1

Pulling rod for TD 82

Part No.: YY 249406.1

Pulling rod for 2 3/8 " API IF Box

Part No.: YY 242827

Pulling rod for 2 7/8 " API IF Box

Part No.: YY 249450

Assembly tool

Part No.: YY 299212

Loosening wrench

Part No.: YY 299208



# Rock drilling technique

## Grundo-Rock-Ream 8 "



HSR HoleOpener 8 " (base body)  
incl. 30 ton chisel und injectors

Part No.: YY 248703

12 " TCI cutter-set = 14 " Ø

Part No.: YY 248560

14 " TCI cutter-set = 16 " Ø

Part No.: YY 248561

16 " TCI cutter-set = 18 " Ø

Part No.: YY 248562

Counter support set 14 " (3 pieces)

Part No.: YY 299254

Counter support set 16 " (3 pieces)

Part No.: YY 299255

Counter support set 18 " (3 pieces)

Part No.: YY 299256

Pulling rod for TD 82

Part No.: YY 249406.1

Pulling rod for EL D80

Part No.: YY 249441

Pulling rod for EL D104

Part No.: YY 249450

Adapter EL D95 box x TD82 pin

Part No.: DRI 232608

Adapter EL D101 box x TD82 pin

Part No.: DRI 235061

# Rock drilling technique

## HSR Hole Opener 10 "



HSR Hole Opener 10 " (Basic body)  
incl. 30 tons swivel and jet nozzles

Part No.: YY 299367

16" cutter set

Part No.: YY 299145

16" cutter set up to 280 MPa

Part No.: YY 299162

18 " TCI cutter set

Part No.: YY 299368

20 " TCI Cutter set

Part No.: YY 299369

20" cutter set up to 280 MPa

Part No.: YY 299154

Counter support set 16"

Part No.: YY 299144

Counter support set 18 " (4 pieces)

Part No.: YY 299370

Counter support set 20 " (4 pieces)

Part No.: YY 299371

Pulling rod for TD 61

Part No.: YY 245063.1

Pulling rod for TD 73

Part No.: YY 245317.1

Pulling rod for TD 82

Part No.: YY 245058.1

Assembly tools

Part No.: YY 299212

Loosening wrench

Part No.: YY 299208

# Rock drilling technique

## PDC Hole Opener 12", 14", 16"

PDC-Hole-Opener with Body 5.5 "1) pulling rod2) Body3) CuttersM1) Cutter 1 - 2 pieces requiredM2) Cutter 2 - 2 pieces requiredWe also strongly recommend using the disassembly aid.

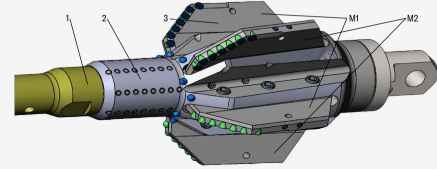

Adapter Elicon 9/6 Box x TD82 Pin

Part No.: DRI 232608

Pulling rod EL D80

Part No.: YY 249441

Pulling rod EL D104

Part No.: YY 249450

Pulling rod TD82

Part No.: YY 249406.1

Body

Pos. 2

**The body 2 7/8" API .IF. Box Thread connection.**

Part No.: YY 248644

Knife 1 - 12" (305mm)

2 pcs. required.

another 2 pieces are needed from knife 2 (YY 248605)

Part No.: YY 248604

Knife 2 - 12" (305mm)

2 pcs. required.

another 2 pieces are needed from knife 1 (YY 248604)

Part No.: YY 248605

Knife 1 - 14" (356mm)

2 pcs. required.

another 2 pieces are needed from knife 2 (YY 248650)

Part No.: YY 248649

Knife 2 - 14" (356mm)

2 pcs. required.

another 2 pieces are needed from knife 1 (YY 248649)

Part No.: YY 248650

Knife 1 - 16" (406mm)

2 pcs. required.

another 2 pieces are needed from knife 2 (YY 248610)

Part No.: YY 248609

Knife 2 - 16" (406mm)

2 pcs. required.

another 2 pieces are needed from knife 1 (YY 248609)

Part No.: YY 248610

Disassembly aid

Disassembly aid for PDC hole opener with body 5.5".

Part No.: YY 248652

## PDC Hole Opener with fixed blades - 8", 10", 12", 14", 16", 18", 20"

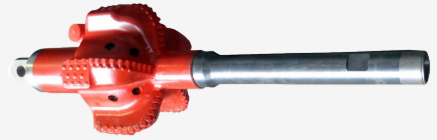

Body incl. swivel 8" Part No.: YY 248666

Body incl. swivel 10" Part No.: YY 248754

Body incl. swivel 12" Part No.: YY 248755

Body incl. swivel 14" Part No.: YY 248756

Body incl. swivel 16" Part No.: YY 248757

Body incl. swivel 18" Part No.: YY 248758

Body incl. swivel 20" Part No.: YY 248759

Adapter on drill rod for ELD 80 - PDC Hole Opener with fixed blades  
Only for 8" Body Part No.: YY 249340

Adapter on drill rod for ELD 95 - PDC Hole Opener with fixed blades  
Only for 8" Body Part No.: DRI 232608

Adapter on drill rod for EL D104 - PDC Hole Opener with fixed blades  
Only for 8" Body Part No.: YY 249456

Adapter on drill rod for TD 82 - PDC Hole Opener with fixed blades  
For 10", 12", 14", 16", 18" and 20" Bodies Part No.: YY 249406.1

Adapter on drill rod for EL D80 - PDC Hole Opener with fixed blades  
For 10", 12", 14", 16", 18" and 20" Bodies Part No.: YY 249441

Adapter on drill rod for EL D95 - PDC Hole Opener with fixed blades  
For 10", 12", 14", 16", 18" and 20" Bodies Part No.: YY 249287

Adapter on drill rod for ELD 104 - PDC Hole Opener with fixed blades  
For 10", 12", 14", 16", 18" and 20" Bodies Part No.: YY 249450

### Hole Opener mit Body 16 "

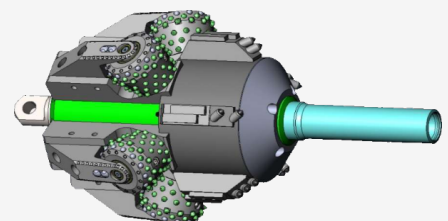

Pulling rod TD 82 Part No.: YY 296223

Pulling rod für EL D104	Part No.: YY 296223
Centralizer 18 "	Part No.: YY 272235
Centralizer 20 "	Part No.: YY 272236
Centralizer 22 "	Part No.: YY 272237
Body incl. 30 to. swivel and nozzles max. tensile force: 150 kN max. speed: 60 1/min	Part No.: YY 272249
Cutter set 22 " max. 220 Mpa max. tensile force: 150 kN max. speed: 60 1/min	Part No.: YY 272238
Cutter set 24 " max. 220 Mpa max. tensile force: 150 kN max. speed: 60 1/min	Part No.: YY 272239
Cutter set 26 " max. 220 Mpa max. tensile force: 150 kN max. speed: 60 1/min	Part No.: YY 272240
Counter support set with screws 22 "	Part No.: YY 272241
Counter support set with screws 24 "	Part No.: YY 272242
Counter support set with screws 26 "	Part No.: YY 272243
Loosening-wrench	Part No.: YY 299208
Assembly-tool	Part No.: YY 299212

# Rock drilling technique

## Centralizer

The CENTRALIZER is a guiding pipe which is attached to the front of the Hole Opener. Its is chosen according to the diameter of the bore and centers the Hole Opener inside the bore with the next upsizing step.  
It guarantees that the Hole Opener is pulled straight along the bore hole bottom and the cutters are strained evenly.



### Centralizer for drill hole-Ø 10 " TD82M x TD118N

Threaded connection: TD82M x TD118N

Ø of the guide tube with hard facing: 230 mm (9 ")

Part No.: DB HF0311230

### Centralizer for drill hole-Ø 10 "

TD82 M x 2 ? "API.IF.N

Part No.: DBHF0319230

### Centralizer for drill hole-Ø 12 " TD82M x TD118N

Threaded connection: TD82M x TD118N

of the guide tube with hard facing: 275 mm (10.8")

Part No.: YY 249475

### Centralizer for drill hole-Ø 12 " TD82M x 2 ? API

Threaded connection: TD82M x 2 7/8 API

Part No.: DB HF0319275

### Centralizer for drill hole-Ø 12 "

Part No.: YY 272223

### Centralizer for drill hole-Ø 14 " TD82M x TD118N

Threaded connection: TD82M x TD118N

of the guide tube with hard facing: 325 mm (12.8")

Part No.: DB HF0311330

### Centralizer for drill hole-Ø 14 " TD82M x 2 7/8 API

Threaded connection: TD82M x 2 ? API

Part No.: DB HF0319325

### Centralizer for drill hole-Ø 16 " TD82M x TD118N

Threaded connection: TD82M x TD118N

of the guide tube with hard facing: 375 mm (14.75")

Part No.: DB HF0311368

### Centralizer for drill hole-Ø 16 " TD82M x 2 7/8 API

Threaded connection: TD82M x 2 ? API

Part No.: DB HF0319375

## Rod release devices

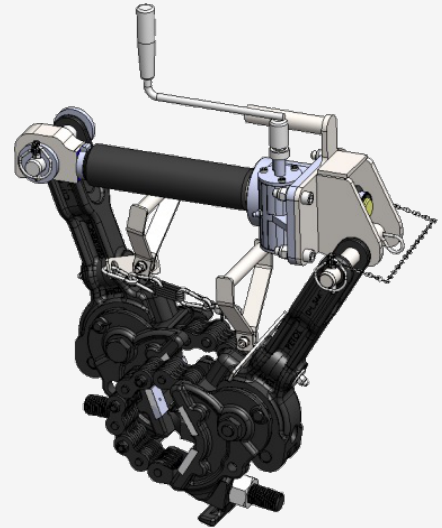

#### Easybreak 7

up to 7000 Nm

Part No.: 6209006

#### Easybrak 19

up to 19000 Nm

Part No.: 6209008

### Adapter

#### Adapter TD 61 socket - RD 49

Sleeve control accessories

Part No.: YY 294116

#### Adapter TD82 sleeve X

TD82 sleeve X

Part No.: YY 249923

#### Adapter TD82 sleeve - 2 ? if-sleve

TD-Vae control accessories

Part No.: YY 296224

#### Adapter 2 3/8 Api.Reg-box

TD 82-box

Part No.: YY 294146

#### Rod adapter prime drilling

3 1/2" M Api Reg to TD82 M

Part No.: YY 249116

#### Adapter TD82 nipple - 2 3/8 IF Socket

Rock drilling control accessories

Part No.: YY 296225

#### Adapter TD 82 plug to

2 3/8" Api.Reg box

Part No.: YY 294186

#### Adapter TD 82 plug to

2 7/8" Api.Reg box

Part No.: YY 294153

#### GW-Adapter TD82 Nipple to

to 3 1/2" Api Reg Socket

Part No.: YY 249095

#### Adapter TD48 Nipple to

TPV Socket for Drill 4X

Part No.: YY 294197

#### GW-adapter TD73 nippel to

TD61 socket

Part No.: YY 249082

<a href="#">Adapter TD82 Nipple to - 2 3/8" API Reg socket</a> TD valve control accessories	Part No.: YY 294134
<a href="#">Adapter TD82 nipple</a> Adapter TD82 nipple - to TD61 socket (long version)	Part No.: YY 294144
<a href="#">Rod adapter TD61 socket</a> X TD82 nipple	Part No.: YY 249030
<a href="#">GW-adapter TD73 socket to</a> 2 3/8" Api.nipple	Part No.: YY 249094
<a href="#">Adapter TD61 nipple to</a> TD73 socket	Part No.: YY 249071
<a href="#">Rod adapter TD73 socket</a> X TD82 nipple	Part No.: YY 249061
<a href="#">Adapter TD82 - socket - 2 3/8 Api.Reg</a> TD-vae control accessories	Part No.: YY 294133
<a href="#">Adapter TD 82 Tt socket -</a> 2 7/8 If- plug	Part No.: YY 296259
<a href="#">Adapter 2 7/8 Api.Reg-plug</a> TD82 box	Part No.: DRI 064070
<a href="#">GW-Adapter TD61 nipple to</a> TD 82 socket, N165, D83	Part No.: YY 294198
<a href="#">Adapter TD 82 socket X</a> 2 3/8" Api.If nipple	Part No.: YY 299373
<a href="#">Adapter 2 7/8"Api.If socket X</a> TD 82 nipple	Part No.: YY 249129
<a href="#">Adapter TD82 nipple X</a> 3 1/2"Api.If. socket	Part No.: YY 249449
<a href="#">Adapter EL D67 socket - TD82 nipple</a> TD82 nipple - EL D 67 socket - TD82 nipple	Part No.: YY 249424
<a href="#">Adapter EL67 Box X EL80 Pin</a>	Part No.: YY 249448
<a href="#">Adapter EL D80 M - TD73 N</a> with internal locking mechnism	Part No.: YY 235031
<a href="#">Adapter EL D80 M - TD73 N</a>	Part No.: YY 243971
<a href="#">Adapter EL D80 M - TD82 N</a> with internal locking mechanism	Part No.: YY 235032
<a href="#">Adapter M. O-Ring</a> EL9-6 D95 socket - TD73 nipple	Part No.: DRI 232609
<a href="#">Adapter EL95M X3 1/2"Api.Reg.N</a>	Part No.: YY 249282
<a href="#">Adapter EL9-6 D95 socket X</a> 2 7/8"Api.If. nipple Kpl	Part No.: YY 249289
<a href="#">Adapter EL9-6 D95 socket X</a> 3 1/2"Api.If. nipple Kpl.	Part No.: YY 249290



Adapter EL D104 socket X 2 3/8"Api.Reg. nipple	Part No.: YY 249463
Adapter TD73 socket X 2 7/8 Api.If. nipple	Part No.: YY 249147
Adapter D90 X NI150 TD73 box - 2 3/8"Api.If. nipple	Part No.: YY 249156
Adapter TD73 socket EL D67 nipple	Part No.: YY 249443
Adapter TD82 socket X 2 3/8 Api.Reg. Pin welded	Part No.: YY 249447
Adapter TD 82 socket X 2 3/8" Api.If nipple	Part No.: YY 299373
Adapter TD 82 socket X 2 3/8" Api.If nipple; nozzle Ø3	Part No.: YY 299373.1
Pulling rod TD82 socket X 2 7/8"Api.If. nipple	Part No.: YY 249406
Adapter TD82 Box X 3 1/2"Api.Reg. nipple	Part No.: YY 249405
Adapter TD 82 socket X Tigges Mt15 AT nipple	Part No.: YY 249445
GW-Adapter TD48 nipple to Tr35 Pit nipples	Part No.: YY 249108
Adapter TD82 Pin X TD82 Pin	Part No.: YY 249984
Twin nipples Tr 34X1/5" for sending house with inner sleeve	Part No.: YY 216197
Adapter TD61 socket X DW-JT 2720 socket	Part No.: YY 249025
GW-Adapter TD61 socket to JT 2720 nipple	Part No.: YY 249107
Adapter Tr34 Pit socket to DW JT 520 nipple	Part No.: YY 249178
Adapter TD61 nipple X DW JT 2720 socket	Part No.: YY 299385
Adapter Dw Jt2720M X TD82N welded	Part No.: YY 235084
Adapter TD73 nipple X Ez-Connect 3 JT3020 SW70	Part No.: YY 249968
Adapter TD48 to Drill 4X socket NI 260 Mm	Part No.: YY 249222
Adapter TD48 nipple to TPV-socket for Drill 4X	Part No.: YY 294197
Adapter TD61 nipple - 4X socket	Part No.: YY 249183

Adapter 4X nipple X Tr34 Pit N

Part No.: YY 249215

Adapter Tpv 4X socket X

Tr34 Pit socket

Part No.: YY 249980

Adapter EL 7-4 D51 nipple

to 4X nipple

Part No.: YY 309553

Adapter TD61 socket to

Firestick 2 3/8" nipple

Part No.: YY 249989

Adapter TD 82 - plug to

2 7/8" Api.Reg - box

Part No.: YY 294153

Adapter TD 82 plug to

2 3/8" Api.Reg box

Part No.: YY 294186

# Detection technique

Different systems for the constant detection of the bore head during the pilot bore.

## DigiTrak Falcon F1®

The Falcon F1™ replaces DCI's popular DigiTrak® SE® and introduces Falcon technology to customers who typically perform short and shallow bores. DCI's Falcon technology minimizes the effect of active interference on jobsites, resulting in increased uptime for HDD crews. The Falcon F1 is a single-band receiver that uses the same frequency optimization technology as other Falcon receivers.

- Falcon frequency optimizer helps minimize the impact of active interference
- The Falcon F1™ single-band transmitter supports frequencies from 9.0 kHz to 13.5 kHz
- Infrared pairing of receiver and transmitter
- 0.1% precision pitch for completing critical grade bores
- Max mode noise filtering boosts fringe data and stabilizes depth readings
- 12-position roll clock with roll offset
- Compatible with DigiTrak Aurora™ touchscreen display



DigiTrak Falcon F1® (no display)



Part No.: SEN 0581.4

DigiTrak Falcon F1® (Falcon Compact Display)



Part No.: SEN 0581.2

DigiTrak Falcon F1® (with AF8 display)



Part No.: SEN 0581.6

# Detection technique

DigiTrak Falcon F1® (with AF10 display)



Part No.: SEN 0581.3

FT1 Sonde 9-13,5 kHz

Transmitting frequencies: 9–13,5 kHz

Pitch resolution:  $\pm 0,1$  %

Depth range: 15,2 m

Data range, Max Mode: 19,8 m

Battery life: up to 20/70 h Alkaline/SuperCell



für Standard-Sendergehäuse

Part No.: SEN 0078 C

for sonde housing 4X

Part No.: SEN 0263

for GRUNDODRILL 18ACS

Part No.: 98CFT1

FT1S Transmitter 9-13,5 kHz

Transmitting frequencies: 9–13,5 kHz

Pitch resolution:  $\pm 0,1$  %

Depth range: 7,6 m

Data range, Max Mode: 9,1 m

Battery life: up to 12 h Lithium 123 3V



Part No.: SEN 0078B

# Detection technique

## DigiTrak Falcon F2®

The classic DigiTrak F2 locating system has earned a reputation as a workhorse that provides customers with dependable locating capabilities. With the introduction of Falcon frequency optimization technology, the DigiTrak Falcon F2 is a more powerful locating system that addresses active interference using a single wideband transmitter.

- Falcon frequency optimizer analyzes and overcomes active interference at different jobsites
- One Falcon F2 wideband transmitter supports multiple frequencies from 4.5 kHz to 45 kHz
- Infrared pairing of receiver and transmitter
- 0.1% precision pitch for completing critical grade bores
- Max mode noise filtering boosts data range and stabilizes depth readings
- Increased power in a 15 in. transmitter for industry-best 24 m depth and 33 m data range
- Supports Roll Offset and Target Steering features
- Compatible with DigiTrak Aurora™ touchscreen display



DigiTrak Falcon F2® (no display)



Part No.: SEN 0579.2

DigiTrak Falcon F2® (Falcon Compact Display)



Part No.: SEN 0579.4

DigiTrak Falcon F2® (with AF8 display)



Part No.: SEN 0579.6

# Detection technique

DigiTrak Falcon F2® (mit AF10 Monitor)



Part No.: SEN 0579.1

FT2 sonde 4,5-45 kHz

Transmitting frequencies: 4,5–45,0 kHz

Pitch resolution:  $\pm 0,1$  %

Depth range: 24,3 m

Data range: 33,5 m

Battery life: up to 20/70 h Alkali/SuperCell



for standard sonde house

Part No.: SEN 0075 C

for sonde housing 4X

Part No.: SEN 0211

for GRUNDODRILL 18ACS

Part No.: 98CFT 2V2

FT2S sonde 9-13,5 kHz

Transmitting frequencies: 9-13,5 kHz

Pitch resolution:  $\pm 0,1$  %

Depth range: 7,6 m

Data range: 9,1 m

Battery life: up to 12 h Lithium 123 3V



for mini sonde housing

Part No.: SEN 0075B

# Detection technique

## DigiTrak Falcon F5®

The Falcon F5® is an extension of the classic F5 locating system. DCI's revolutionary Falcon technology minimizes the effects of active interference (noise) on the jobsite with a single wideband transmitter. The Falcon F5 combines this new technology with everything a professional contractor values in DCI's flagship F5 locating platform, including superior ease of use, updated DataLog software, and fluid pressure monitoring.

- Falcon frequency optimizer helps overcome active interference
- One Falcon F5 wideband transmitter supports multiple frequencies from 4.5 kHz to 45 kHz
- Infrared pairing of receiver and transmitter
- 0.1% precision pitch for completing critical grade bores
- 24-position roll clock with roll offset
- Max mode noise filtering boosts fringe data and stabilizes depth readings
- Increased power in a 19 in. transmitter for industry-best 38.1 m depth and 45.7 m data range
- Supports DataLog, Log-While-Drilling, and Target Steering features
- Compatible with DigiTrak Aurora touchscreen display



DigiTrak Falcon F5® (no display)



Part No.: SEN 0574.4

DigiTrak Falcon F5® incl. GPS module (no display)

Part No.: SEN 0590

DigiTrak Falcon F5® (Falcon Compact Display)



Part No.: SEN 0574.2

DigiTrak Falcon F5® incl. GPS module (Falcon Compact Display)

Part No.: SEN 0591

# Detection technique

DigiTrak Falcon F5® (with AF8 display)



Part No.: SEN 0574.6

DigiTrak Falcon F5® incl. GPS module (with AF8 display)

Part No.: SEN 0592

DigiTrak Falcon F5® (with AF10 display)



Part No.: SEN 0574.3

DigiTrak Falcon F5® incl. GPS module (with AF10 display)

Part No.: SEN 0593

FT5Lp Sonde 4,5-45 kHz

Transmitting frequencies: 4,5–45,0 kHz

Pitch resolution:  $\pm 0,1$  %

Depth range: 38,1 m

Data range, Max Mode: 45,7 m

Battery life: up to 40 h SuperCell



for long sonde housing

Part No.: SEN 0076B

for GRUNDODRILL 18ACS

Part No.: 98CFT5LP

FT5p Sonde 4,5-45 kHz

Transmitting frequencies: 4,5–45,0 kHz

Pitch resolution:  $\pm 0,1$  %

Depth range: 30,5 m

Data range, Max Mode: 38,1 m

Battery life: up to 20/70 h Alkali/SuperCell



for standard sonde housing

Part No.: SEN 0076 C

for sonde housing 4X

Part No.: SEN 0212

für GRUNDODRILL 18ACS

Part No.: 98CFT5P V2



# Tensile load measuring

For logging and controlling the tensile loads with a measuring precision of 0,1 %

## Grundolog Type III (self-sustaining or wireless)

Grundolog is a measuring system for documenting and controlling the tensile loads affecting the new pipe during installation. These tensile loads are recorded at a measuring precision of 0,1 % from the nominal value. The light weight and the short structural shape allow simple assembly and easy handling. The measuring bodies are battery-driven. The system includes battery charger, cable and software. The connection to swivel and pipe puller is designed for the max. pulling force.

With wireless version the tensile loads are logged and transferred online through the soil to the operator. With GRUNDODRILL N, XP, XPT and 18ACS the data are indicated at the operator panel, thus providing the possibility to influence the pulling process.

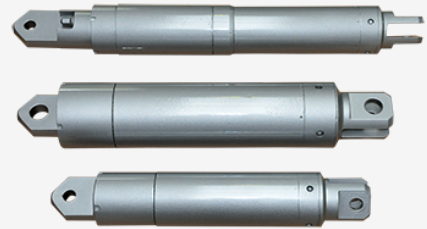

### Grundolog 150 kN self-sustaining, for swivel Type II

Grundolog is a measuring system for documenting and controlling the tensile loads affecting the new pipe during installation. These tensile loads are recorded at a measuring precision of 0,1 % from the nominal value. The light weight and the short structural shape allow simple assembly and easy handling. The measuring bodies are battery-driven. The system includes battery charger, cable and software. The connection to swivel and pipe puller is designed for the max. pulling force.



Part No.: DRI K1E1AA



Part No.: DRI K3B1BB

### Grundolog 400 kN self-sustaining, for swivel Type III

Grundolog is a measuring system for documenting and controlling the tensile loads affecting the new pipe during installation. These tensile loads are recorded at a measuring precision of 0,1 % from the nominal value. The light weight and the short structural shape allow simple assembly and easy handling. The measuring bodies are battery-driven. The system includes battery charger, cable and software. The connection to swivel and pipe puller is designed for the max. pulling force.



Part No.: DRI K3B1CC

# Tensile load measuring

Grundolog 150 kN wireless, for GRUNDODRILL N-series



Part No.: DRI K3E1N15

Grundolog 150 kN wireless, for GRUNDODRILL X-series

Part No.: DRI K3E1X15

Grundolog 400 kN wireless, for GRUNDODRILL N-series



Part No.: DRI K3B4N40

# Tensile load measuring

Grundolog 400 kN wireless, for GRUNDODRILL X-series

Part No.: DRI K3B4X40

Hinged hook wrench for fastening the protection sleeve



Part No.: 220470247

# Trenchless cable exchange

## Wash-over head Type 1

Energy suppliers are increasingly obliged to replace unused or damaged ground cables with new ones. The wash-over-technique by TRACTO-TECHNIK is a simple and economic method for the trenchless exchange of cables using a GRUNDODRILL HDD system. To do so, the drill rod is connected to the patented wash-over head and guided parallel over the old cable.

The old cable acts as a compelled guidance for the wash-over-head which cuts and flushes the adhesive soil surrounding the old cable and existing roots creating a small annular space. At the target the old cable can easily be extracted with a pulling device. Due to the compelled guidance a detection system is not necessary. Yet additional monitoring of the bore path is recommended to be able to correct deviations from the given bore path immediately. When pulling back the drill rods, the new cable attached is pulled in simultaneously.

With connection for sonde housing TD61.  
For cables, PE pipes, stuck drill rods, etc.



Wash-over head with flex piece ID 45 mm

Part No.: YY 246638

Wash-over head with flex piece ID 72 mm

Part No.: YY 246578

Wash-over head with flex piece ID 98 mm

Part No.: YY 246591

Wash-over head with flex piece ID 115 mm

Part No.: YY 246622

Wash-over head with flex piece ID 135 mm

Part No.: YY 246600

# Trenchless cable exchange

## Wash-over head Type 2

This wash-over head is especially suitable for wash-over bores with cables lying close below covers. The cutting geometry optimises the guidance on the pipe to be washed-over without getting hooked inside the surface cover overhead.

With connection for sonde housing TD61.  
For cables, PEpipes etc.



Wash-over head with flex piece ID 72 mm

Part No.: YY 246708

Wash-over head with flex piece ID 98 mm

Part No.: YY 246657

Wash-over head with flex piece ID 115 mm

Part No.: YY 246650

Wash-over head with flex piece ID 135 mm

Part No.: YY 246693

Adapter for TD73 sonde housing

Part No.: YY 246787

Adapter for TD82 sonde housing

Part No.: YY 246838

# Retrieval tools

Tools for retrieving stuck drill rods, backreamer with swivel and pulling head.

## Pipe Cutter

Pipe cutters are applied to detach stuck PE pipes from the pulling head (pipe puller) in order to be able to recover at least drill rods, backreamer and swivel.

Pipe Cutter TD 61 socket, Ø 110 mm	Part No.: YY 298775
Pipe Cutter TD 61 socket, Ø 125 mm	Part No.: YY 298784
Pipe Cutter TD 61 socket Ø 140 mm	Part No.: YY 298786
Pipe Cutter TD 82 socket, Ø 160 mm	Part No.: YY 298762
Pipe Cutter TD 82 socket, Ø 180 mm	Part No.: YY 298763
Pipe Cutter TD 82 socket, Ø 225 - Ø 250 mm	Part No.: YY 298767
Pipe Cutter TD 82 socket, Ø 280 mm	Part No.: YY 299711
Pipe Cutter TD 82 socket, Ø 315 mm	Part No.: YY 299770
Pipe Cutter TD 82 socket, Ø 355 mm	Part No.: YY 249605
Pipe Cutter TD 82 socket, Ø 450 mm	Part No.: YY 298799

# TRACTO-TECHNIK GMBH & CO. KG HEADQUARTERS

PAUL-SCHMIDT-STRASSE 2  
57368 LENNESTADT, GERMANY  
T +49 2723 808-0  
F +49 2723 808-180  
INFO@TRACTO.COM  
TRACTO.COM/DE



TRACTO.COM

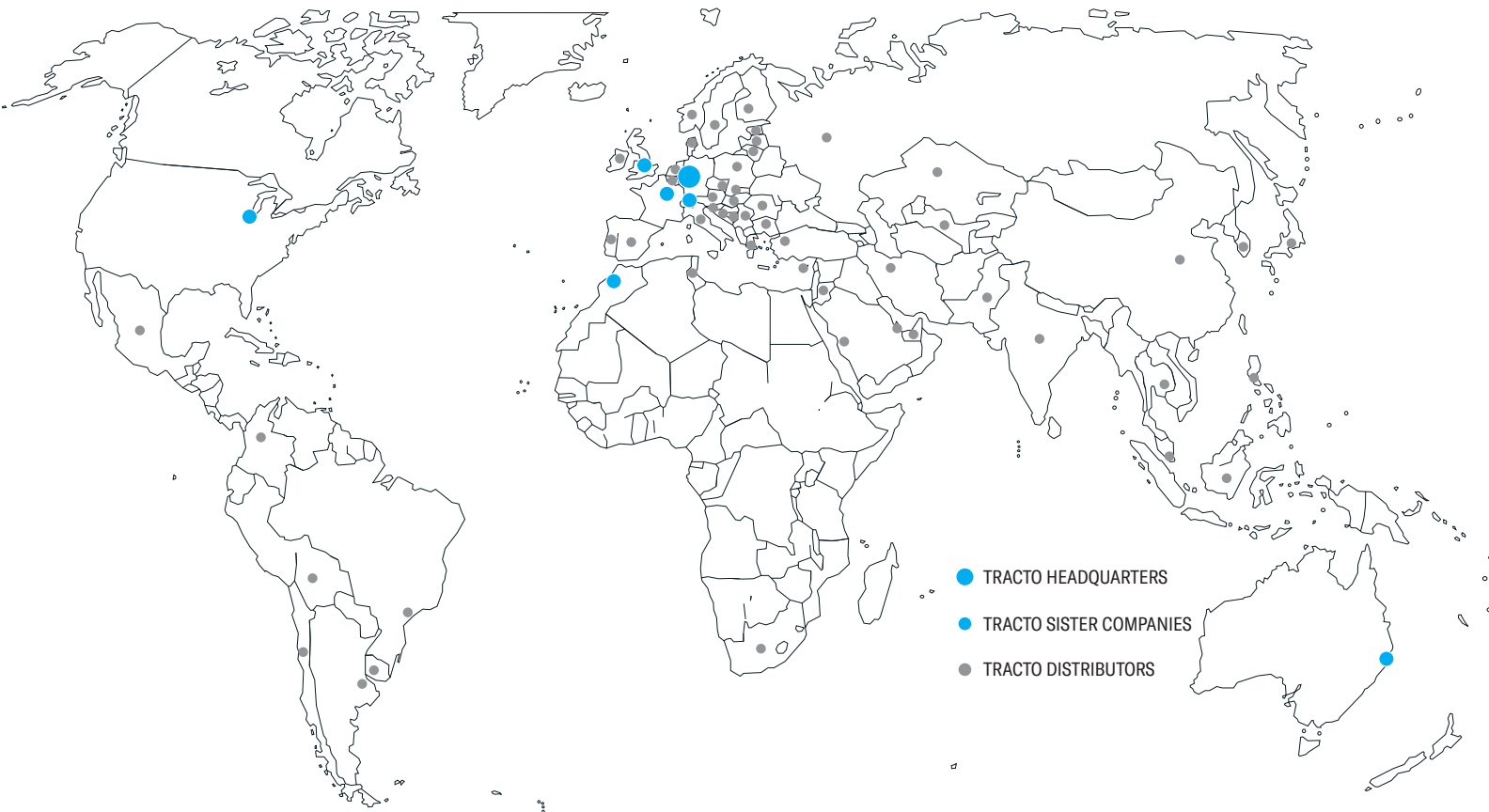

SWITZERLAND  
TRACTO-TECHNIK SCHWEIZ AG  
INDUSTRIESTRASSE 4  
8360 ESCHLIKON TG, SCHWEIZ  
T +41 79 8203897  
CH@TRACTO.COM  
TRACTO.COM/CH-FR

UNITED KINGDOM  
TRACTO-TECHNIK UK LTD  
10 WINDSOR ROAD  
BEDFORD MK 42 9SU  
T +44 1234 342566  
F +44 1234 352184  
INFO@TRACTO-TECHNIK.CO.UK  
TRACTO.COM/UK

FRANCE  
TRACTO-TECHNIK FRANCE S.A.R.L.  
1/3 RUE DE LA PRAIRIE  
F-77700 BAILLY ROMAINVILLIERS  
T +33 1 60 42 49 40  
F +33 1 60 42 49 43  
FR@TRACTO.COM  
TRACTO.COM/FR

USA  
TT TECHNOLOGIES INC.  
2020 EAST NEW YORK STREET  
AURORA, IL. 60502  
T +1 630 851 8200  
F +1 630 851 8299  
INFO@TTTECHNOLOGIES.COM  
TTTECHNOLOGIES.COM

AUSTRALIA  
TRACTO-TECHNIK AUSTRALIA PTY LTD.  
10 ALICIAJAY CIRCUIT  
LUSCOMBE, QLD 4207  
T +61 7 3420 5455  
AU@TRACTO.COM  
TRACTO.COM/AU

MOROCCO  
TRACTO-TECHNIK AFRIQUE S.A.R.L.  
ROUTE DE TAMESNA 4022  
POSTE 2044, 12220 TAMESNA  
T +212 5 37 40 13 63 / 64  
F +212 5 37 40 13 65  
INFO@TRACTO-TECHNIK.MA  
TRACTO.COM/MA

## TRACTO ADVANCED TRENCHLESS TECHNOLOGY

TRACTO PARTNER: