

TRACTO

Further Information
on GRUNDOMAT

TRACTO.COM/GRUNDOMAT



GRUNDOMAT
SOIL DISPLACEMENT
HAMMERS
UNBEATABLE:
THE ORIGINAL

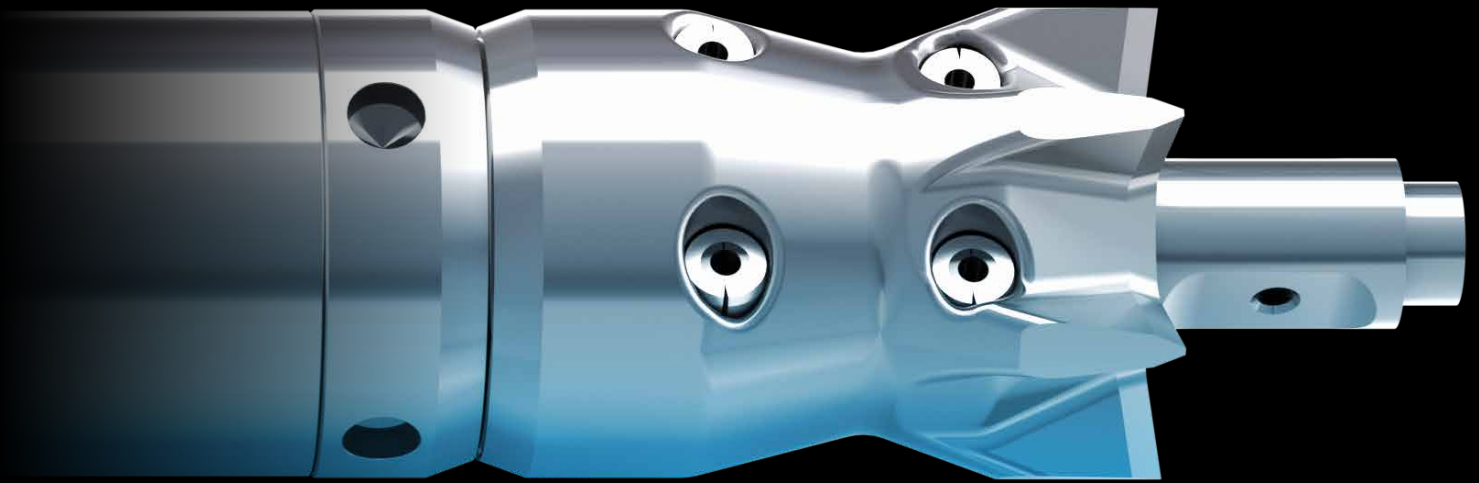

ADVANCED TRENCHLESS TECHNOLOGY

GRUNDOMAT

THE NEW GENERATION

Strikingly smart

For more than five decades, GRUNDOMAT soil displacement hammers have stood for on-target underground pipe installation. Their exceptional longevity and high precision stem from the smart design, uncompromising quality and consistent development of our „moles“. We never lose track of the requirements of users and the trends in pipeline construction. So that you can tackle your jobs faster and easier, we made the complex technology even more durable, reliable and easy to handle. That's what we call „simple & easy“.

Reliability revisited

The new generation of GRUNDOMAT soil displacement hammers corresponds exactly to this principle. The optimised design combines all the benefits of previous series with new technical solutions. The distinctive characteristics of the GRUNDOMAT, such as the movable head for unbeatable power and pinpoint accuracy and the use of the highest quality materials for long construction site operations, make the GRUNDOMAT a reliable partner on your construction sites.

The servo control for small machines is new and an intelligent internal design guarantees a long machine life. For the user this means the highest possible productivity and maximum efficiency for pipe installation.

APPLICATION

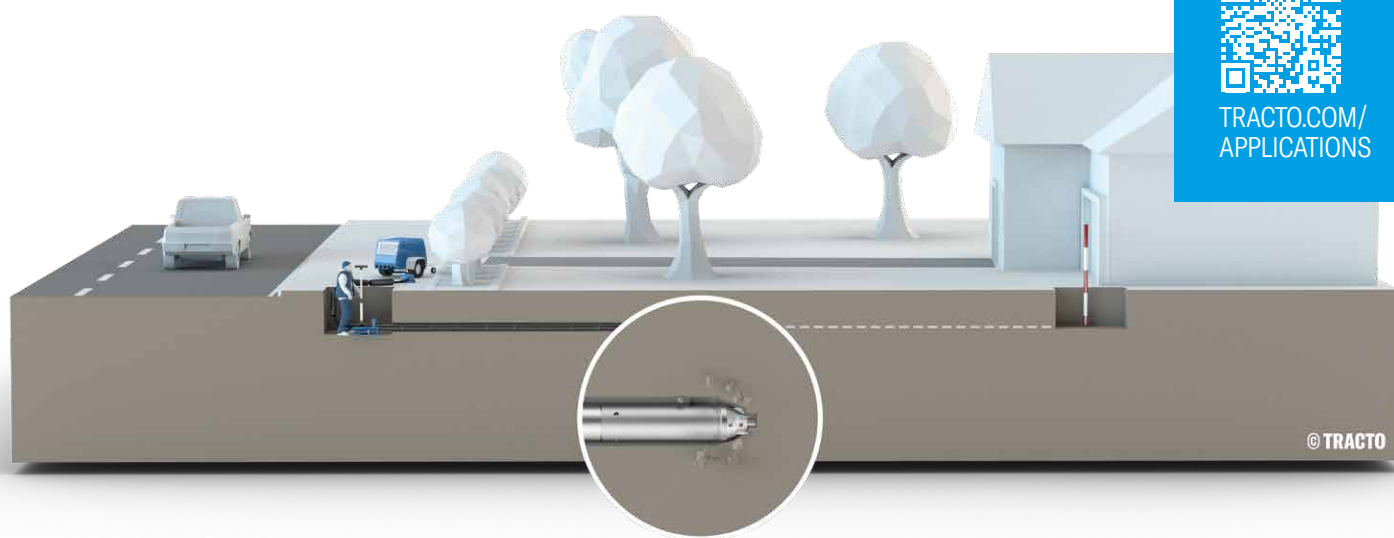

GRUNDOMAT
Application
Videos at



TRACTO.COM/
APPLICATIONS

Application example Fibre-glass expansion FTTX

BORE TYPE



BORE DIAMETER

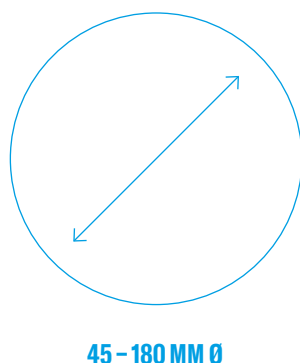

MAIN APPLICATIONS

HOUSE
CONNECTIONS

UNDER-
CROSSINGS

SPECIAL APPLICATIONS

PIPE
RENEWAL
(from type 95)

PIPE RAMMING
(from type 130)

DRIVING OUT
STEEL PIPES

PILE FOUNDA-
TIONS

OVERVIEW

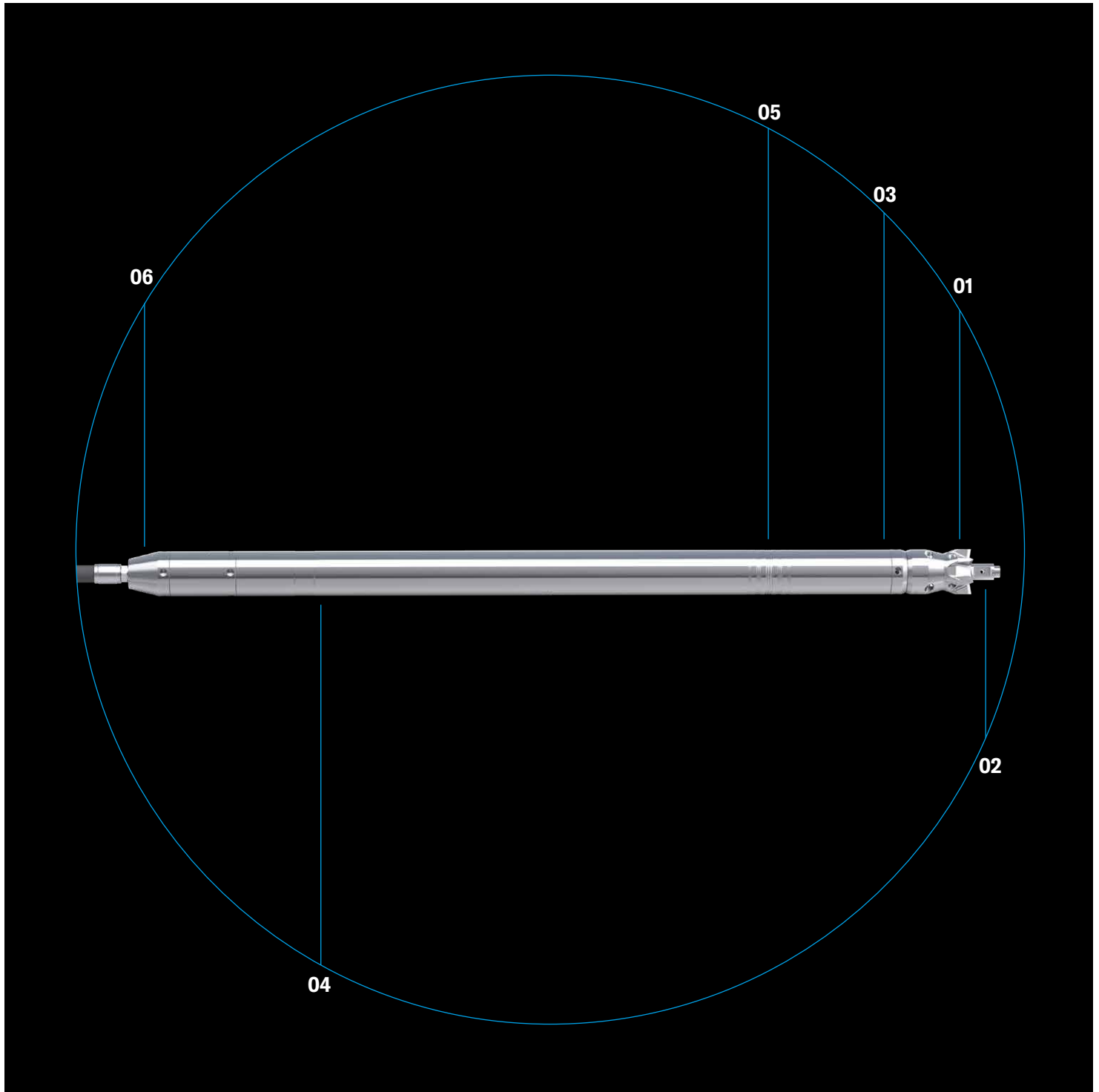

01 Crowned or stepped head with two-stroke method for maximal target precision and high running stability.

02 Concentration of impact energy in thrust direction onto the sharp cutting edges for high penetration force.

03 No front machine seal – enormous longevity and optimal energy transfer.

04 Low-wear and low-maintenance housing – chrome-plated inside and outside, also honed inside for high durability, ensure a sustained maximum performance.

05 Easy-to-read wear indicator on the smooth outer housing.

06 Various mounting options for a variety of applications beyond the standard, e.g. immediate piping, pile foundations or driving out steel pipes.

GRUNDOMAT THE ORIGINAL

ALL IN THE HEAD - CROWNED OR STEPPED HEAD

Crowned head

Our users appreciate the crowned head especially in loose, stony and densely packed soils, thanks to its aggressiveness and enormous penetration force in hard ground conditions. Experienced drilling professionals are of the opinion: „This head lets nothing hold it back in achieving its goal“.

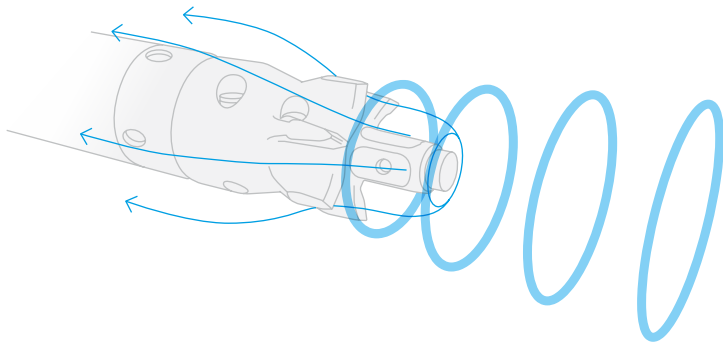

For optimum adaptation to various soil conditions, the GRUNDOMAT soil displacement hammers can be equipped with movable crowned or stepped heads. Both versions operate with equal precision, stability and efficiency, each in their own way.

Stepped head

The stepped head, which has been tried and tested for decades, is universally applicable in all displaceable soils and is the „classic“ among the soil displacement hammers.

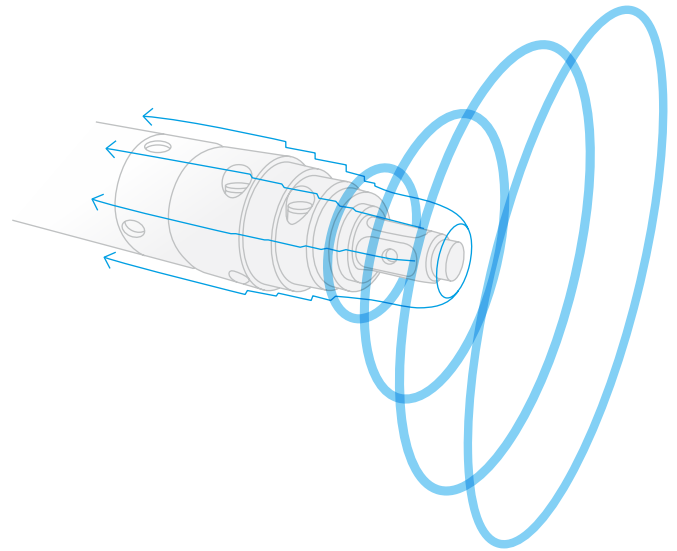

ALWAYS RIGHT ON TIME - THE TWO-STROKE PRINCIPLE

Stroke one

During the first stroke, the piston acts on the cutter so that the head cuts the borehole and crushes and removes any obstacles. The impact energy of the piston is concentrated on the cutter and the bore head.

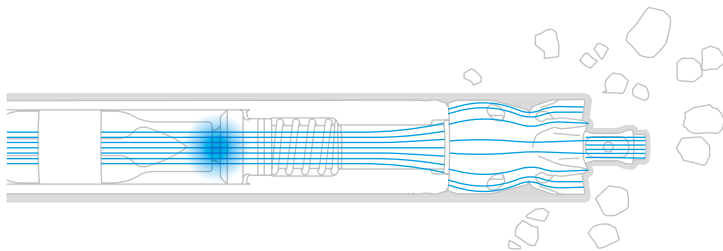

Stroke two

In the second stroke, the drill head moves freely in the borehole and the full impact energy of the piston is transferred to the housing. The entire machine follows up, with a pipe attached as the case may be.

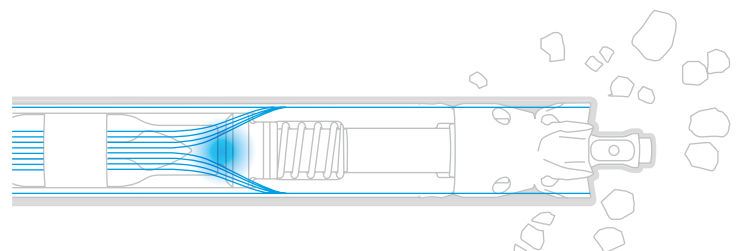

The intelligent 2-stroke principle brings the impact energy to where it is needed. To overcome surface friction or peak resistance. This way the GRUNDOMAT soil displacement hammer achieves its almost legendary precision, even in difficult soils.

Energy flow



SUSTAINED MAXIMUM PERFORMANCE

THE NEW GENERATION

High penetration force and powerful thrust also with maximum load thanks to specially hardened, corrosion-protected pistons

Minimum air consumption at highest power thanks to innovative piston technology and a sophisticated sealing system

Optimum performance through regular service with replacement of inexpensive slip belts and sealing rings

Extremely long service life of chisel with use of bearing bush

Reliable and on-target thrust in two-stroke cycle thanks to movable head with unique seal

The design of the new GRUNDOMAT generation is the result of a careful development process focussing on user-friendliness. Combined with the proven reliability of our technology, we can give the user durable technology for trenchless pipe installation that is customised to their construction sites.



EASY SHIFTING: SERVO OR THRUST CONTROL

Servo control

Our servo control simplifies shifting between forward and reverse gear with a simple flip of the lever. The integrated oil-fog lubricator supplies the machine with GRUNDOOIL and at the same time guarantees maximum power and penetration force.

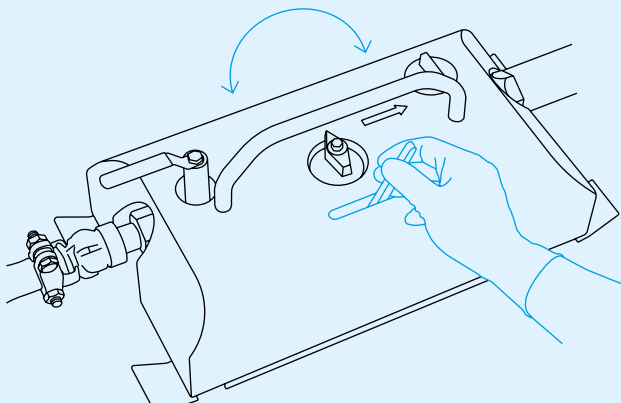

Thrust control

Our GRUNDOMAT with the proven thrust control is switched from forward to reverse gear by simply turning the compressed air hose. The soil displacement hammer is supplied with oil by the oil-fog lubricator.

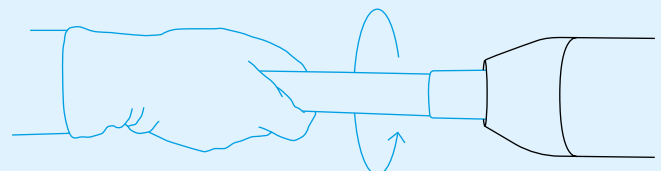

VARIATIONS

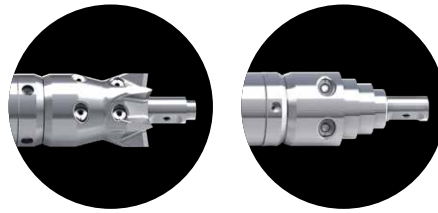

All soil displacement hammers also available with stepped head.

GRUNDOMAT

FEATURES

- 2-stroke-principle for high aiming accuracy
- Robust and low-wear design for long-lasting peak performance
- Service-friendly construction with only onesided machine closure
- Versatile mounting options for a broad range of applications
- Alternatively available with hose or servo control for user-friendly jobsite applications
- Operator safety packages available

TYP	45	55	65	75	85	95	110	130	145	180
Ø (mm)	45	55	65	75	85	95	110	130	145	180
Length (mm)	979	1.108	1.328	1.465	1.550	1.732	1.751	1.740	2.010	2.212
Weight (kg)	9	14,4	25	34	46	65	96	117	168	260
Air consumption (m³/min)	0,35	0,4	0,7	1,0	0,95	1,5	1,6	2,6	3,4	4,5
Impact rate (min ⁻¹)	Thrust control	530	470	450	385	370	325	320	-	-
	Servo control	-	-	460	400	370	325	320	310	260
Max. pipe Ø (mm)	32	45	50	63	75	85	90	110	125	160

Subject to change.

GRUNDOMAT SHORT VERSION

FEATURES

- Same as standard version
- Shortened overall length for use in confined spaces
- Particularly suitable for short bore lengths
- Reduced machine weight for easier handling

TYP	S45	S65	S75	S95	S110	S130
Ø (mm)	45	65	75	95	110	130
Length (mm)	894	1.097	1.295	1.532	1.548	1.604
Weight (kg)	8	18	28	56	86	107
Air consumption (m³/min)	0,35	0,65	0,8	1,3	1,4	2,4
Impact rate (min ⁻¹)	Thrust control	580	570	490	370	370
	Servo control	-	640	460	370	370
Max. pipe Ø (mm)	32	50	63	85	90	110

Subject to change.



**Order now
at our
eSHOP**



[eSHOP.TRACTO.COM](https://eshop.tracto.com)

GRUNDOMAT ALL ANGLES COVERED

A large selection of accessories for various jobs on the construction site make the GRUNDOMAT versatile and ensures high capacity utilisation. Our original accessories make the application as simple and safe as possible for the operator.

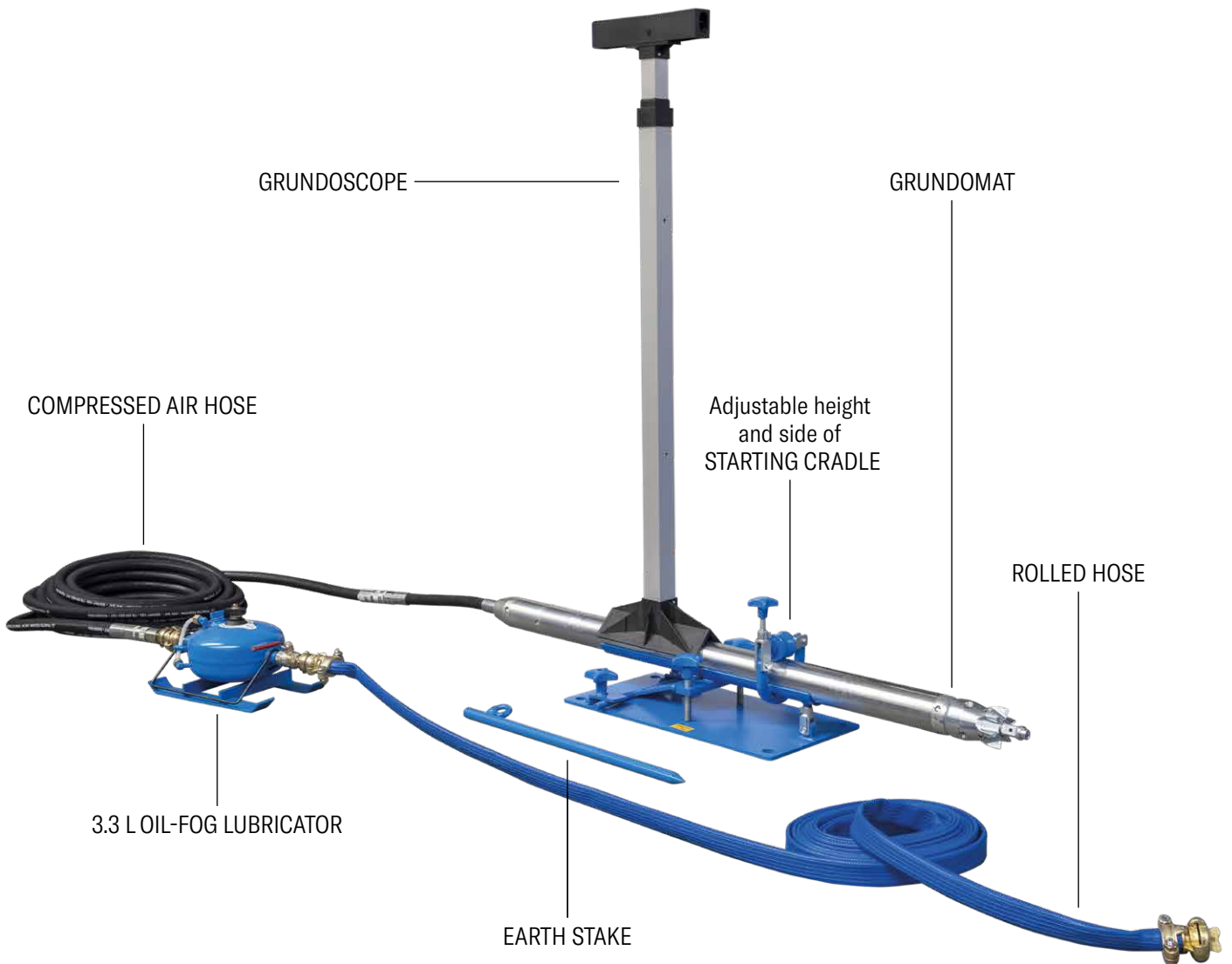

ON TARGET WITH GRUNDOSCOPE

Aiming at the target point with the GRUNDOSCOPE, a telescopic aiming frame with integrated sight, is a prerequisite for successful pipe jacking. The use of a starting cradle makes the start easier and guarantees precise alignment.



GRUNDO-OIL

Our biodegradable GRUNDOOIL guarantees optimal running properties and a long life of the soil displacement hammers..



UNITHERM

Compressed air heaters prevent the impact holes freezing over. This means you can also work in the winter months.



GRUNDEX MUD PUMP

Compressed air operated water and mud discharge pump for work pits



ATTACHMENT MANDREL

For driving out old steel pipes and simultaneous pulling-in of new pipes.



EXPANDER AND TOWING EYE

For pipe renewal (cracking) from type 130 and expansion of existing boreholes.

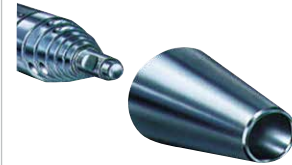

ATTACHMENT RAM CONE

For steel pipe driving.

PIPE INSTALLATION

Several GRUNDOMAT attachments are available for successful pipe installations

Non-cohesive soils

Sleeve pipe for the immediate installation of short PVC pipes

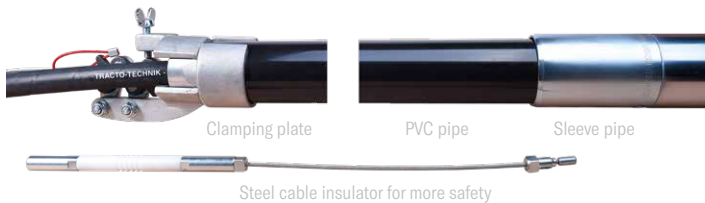

PE pipe connection for the immediate installation of long PE pipes

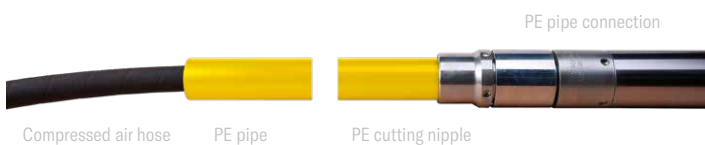

Cohesive soils

Return cone for working in reverse gear in cohesive soils



Pulling adapter for pulling in reverse, using compressed air hoses subsequent pulling-in of long PE pipes



Draw hook for pulling in reverse, using soil displacement hammers subsequent pulling-in of long PE pipes with pipe puller



FULL SERVICE FOR TRENCHLESS TECHNOLOGY

Whether its before, during or after the purchase, whether in person or online – we are always at your side with advice and support. Our wide-ranged service is specially tailored to the requirements of trenchless pipe installations, so you can concentrate fully on your core business.

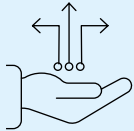

Digital Solutions

Our website offers you the whole world of trenchless technology in digital form. Find out more about our company, our products and their applications. Discover the digital tools for the HDD drilling technology and many other intelligent solutions. Always stay up to date by using the links to our social media channels. Or you can order machines, accessories and spare parts in our eSHOP – easy and conveniently via PC, smartphone or tablet.

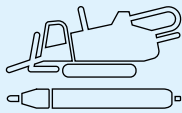

Nodig Product Specialists

You can truly rely on our product specialists for all technical questions regarding the function and application of our steerable and non-steerable NODIG-systems. With comprehensive knowledge in each of their special fields, you can be sure they will find the best solution for your trenchless projects and advise you competently on setting up your jobsite.



Financing

We offer attractive financing solutions for new and used machines to our customers and sales partners through the TRACTO-TECHNIK Finance GmbH. Be it financing, hire purchase, various types of leasing or insurance: we provide extensive expert advice, individually and personally, in order to find the tailored solution for you. Discretion goes without saying.



Training

Qualified training enables you to apply trenchless technology even more effectively and profitably. Our wide range of training courses for machine operators, construction professionals as well as planners and clients cover all aspects of NODIG technology, including special topics. Certified trainers also instruct you, in theory and practice according to your individual requirements, either at one of our numerous company locations, or directly on your own premises or online, independent of time and place.

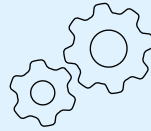

Specialised Civil Engineering Service (Application Technology)

The specialised civil engineering service for application technology provides support for all your trenchless construction sites. Our experts demonstrate the steerable and non-steerable NODIG technology live in practical use, show your drilling teams how to use it or actively assist with special projects.



Geoservice

Precise knowledge of the soil is the key to successful trenchless projects. Our Geoservice team provides you with this professional knowledge. Our expertise puts you in a position to master every type of soil. Based on geoscientific maps and existing construction files, we supply information on the soil, which will help you with calculations or supplements.



Used Equipment

If you want to sell a used machine at an attractive price or are looking for the right equipment for your tasks, our full service for used NODIG machines will take the workload off your hands – from appraisal and price determination to professional repair and certification, through to achieving the best price for you via our used machine website with access to one of the world's largest construction machinery platforms.

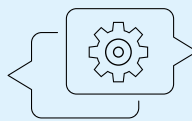

After Sales

Via our worldwide service network we are always there for you, even after the purchase. A total of five TRACTO plants and seven customer centres in Germany, as well as our worldwide sister companies and sales partners guarantee fast supply of spare parts and immediate availability. Our competent service staff offer fast assistance, to ensure you don't lose any time.

**Discover all
Services**



[TRACTO.COM/
SERVICES](https://tracto.com/services)

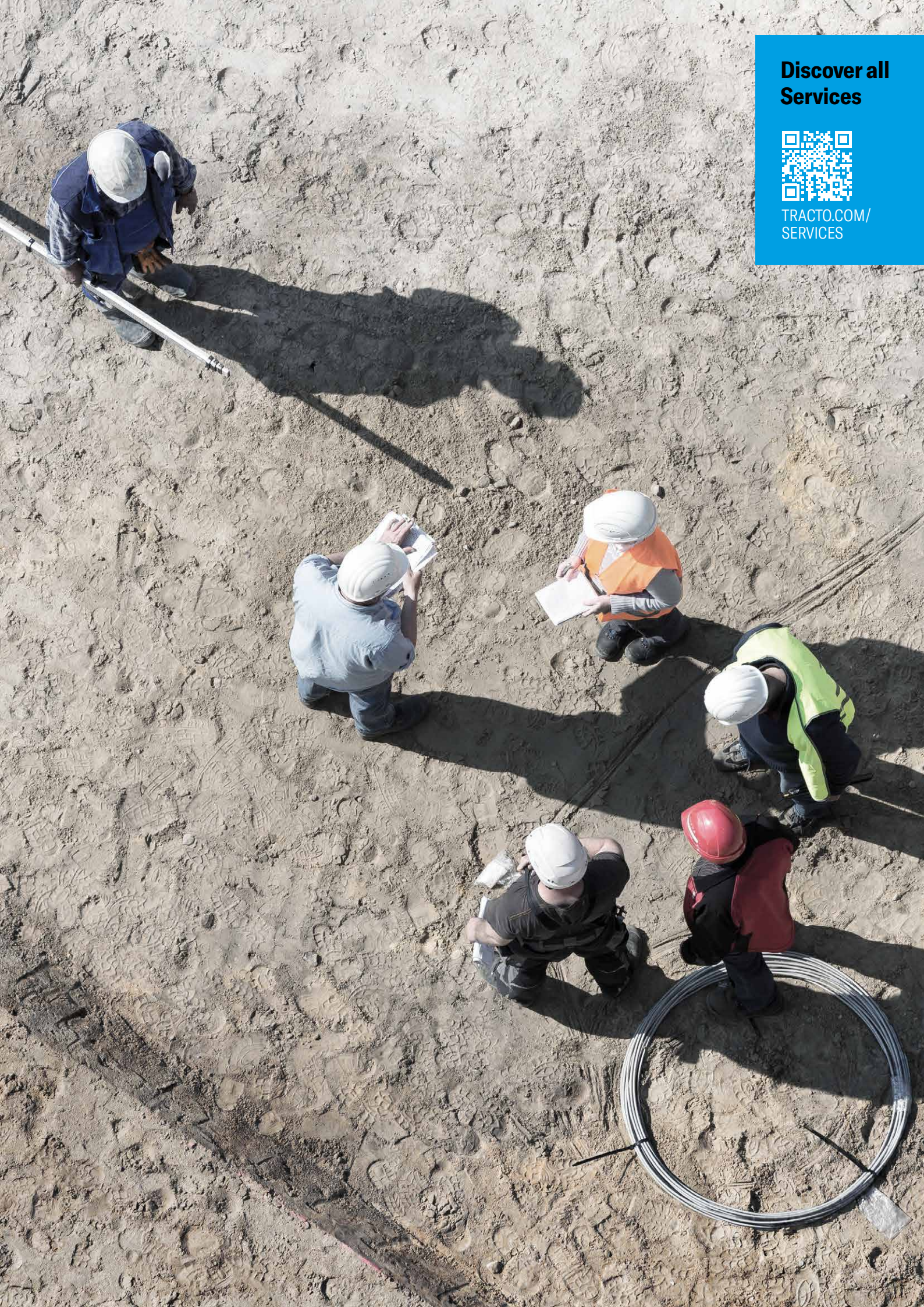

**TRACTO-TECHNIK
GMBH & CO. KG
HEADQUARTERS**

PAUL-SCHMIDT-STRASSE 2
57368 LENNESTADT, GERMANY
T +49 2723 808-0
F +49 2723 808-180
INFO@TRACTO.COM
TRACTO.COM/DE



TRACTO.COM

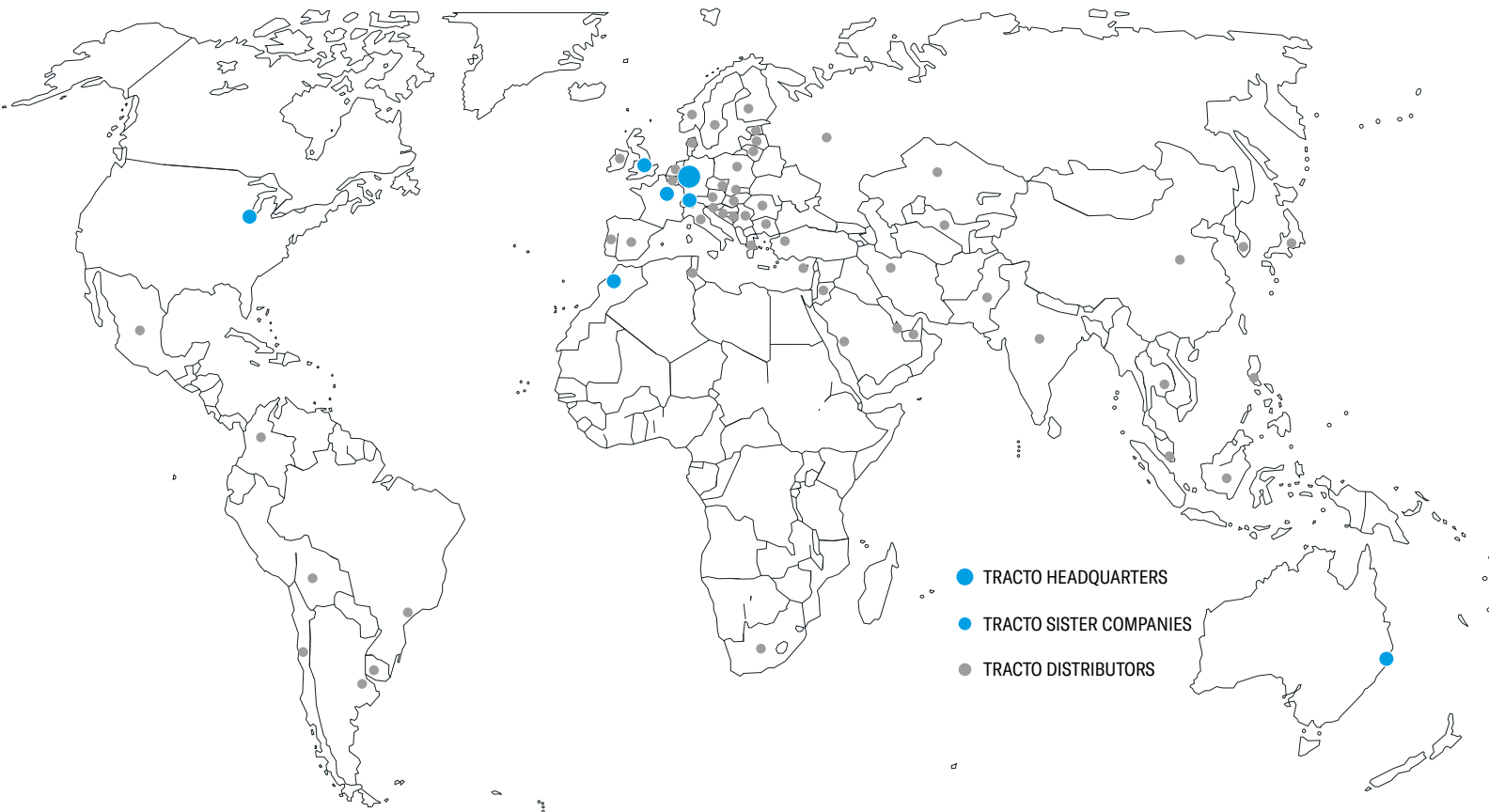

- TRACTO HEADQUARTERS
- TRACTO SISTER COMPANIES
- TRACTO DISTRIBUTORS

SWITZERLAND
TRACTO-TECHNIK SCHWEIZ AG
INDUSTRIESTRASSE 4
8360 ESCHLIKON TG, SCHWEIZ
T +41 79 8203897
CH@TRACTO.COM
TRACTO.COM/CH-FR

UNITED KINGDOM
TRACTO-TECHNIK UK LTD
10 WINDSOR ROAD
BEDFORD MK 42 9SU
T +44 1234 342566
F +44 1234 352184
INFO@TRACTO-TECHNIK.CO.UK
TRACTO.COM/UK

FRANCE
TRACTO-TECHNIK FRANCE S.A.R.L.
1/3 RUE DE LA PRAIRIE
F-77700 BAILLY ROMAINVILLIERS
T +33 1 60 42 49 40
F +33 1 60 42 49 43
FR@TRACTO.COM
TRACTO.COM/FR

USA
TT TECHNOLOGIES INC.
2020 EAST NEW YORK STREET
AURORA, IL. 60502
T +1 630 851 8200
F +1 630 851 8299
INFO@TTTECHNOLOGIES.COM
TTTECHNOLOGIES.COM

AUSTRALIA
TRACTO-TECHNIK AUSTRALIA PTY LTD.
10 ALICIAJAY CIRCUIT
LUSCOMBE, QLD 4207
T +61 7 3420 5455
AU@TRACTO.COM
TRACTO.COM/AU

MOROCCO
TRACTO-TECHNIK AFRIQUE S.A.R.L.
ROUTE DE TAMESNA 4022
POSTE 2044, 12220 TAMESNA
T +212 5 37 40 13 63 / 64
F +212 5 37 40 13 65
INFO@TRACTO-TECHNIK.MA
TRACTO.COM/MA

**TRACTO
ADVANCED TRENCHLESS TECHNOLOGY**

TRACTO PARTNER:

Images, text and graphics subject to change. Some of the product or service designations listed below as well as depicted logos are registered trademarks of TRACTO and in these cases are subject to the respective applicable trademark law.